

MANDÍK[®]

VARIABLE AIR VOLUME FLOW CONTROLLER FOR LOW VELOCITIES

RPM-LV



These Technical Specifications determine type range RPM-LV of variable air volume flow controllers for low velocities (hereinafter also referred to as "controllers").
It is valid for the design, production, ordering, delivery, installation, commissioning, operation and maintenance.

I. CONTENT

II. GENERAL INFORMATION	3
1. Description.....	3
2. Design.....	4
3. Dimensions, weights.....	5
4. Installation in the duct.....	6
III. TECHNICAL DATA	7
5. Basic parameters.....	7
6. Electric parameters.....	9
7. Determination of actual air volume.....	11
8. Pressure drop.....	11
9. Noise data.....	12
IV. MATERIAL, FINISHING	24
10. Material.....	24
V. INSPECTION, TESTING	24
11. Inspection.....	24
12. Testing.....	24
VI. TRANSPORTATION AND STORAGE	24
13. Logistic terms.....	24
14. Warranty.....	24
VII. INSTALLATION, OPERATION, MAINTENANCE AND REVISIONS	25
15. Installation and commissioning.....	25
VIII. QUICK SELECTION GUIDE	26
16. Controller size selection.....	26
IX. ORDERING INFORMATION	27
17. Ordering key.....	27

II. GENERAL INFORMATION

1. Description

- 1.1. Air flow controllers are intended for the use in buildings, installed in air supply or air exhaust ducts of HVAC systems. Controlling the air flow in different branches of the system, the air is directed to where needed when needed in order to assure both well-being and economic operation.

The controllers with variable air flow rate consist of the air-tight body, air-tight damper blade firmly mounted on a shaft, electric actuator, air flow rate measuring system, and of the electronic controller including communication interface.

RPM-LV air flow controllers represent the latest generation of devices based on differential pressure air flow measurement principle, benefiting from intensive local variations of the pressure field around the damper blade. MANDÍK design profit from many years of experience with production of accurate, robust and reliable air flow controllers combined with innovation drive and state-of-the-art laboratory testing. In addition to precisely controlled production process, high-end components from top suppliers contribute to performance fully exploiting the potential of the basic principle of function, benefiting also from the input from our customers, designers of HVAC systems, installers and end users.

RPM-LV air volume flow controllers for low velocities are protected by utility patent No. 33127 and utility patent No. 20 2019 104 939.

The controllers are characterized by:

- very short length of the device
- low weight
- small demands on the installation space
- wide range of air flow rates
- working from low air velocities
- low minimum control pressure drop
- low noise levels
- absence of necessary downstream straight section and absence of upstream straight section under certain conditions
- extremely simple design with minimum moving parts and minimum hidden parts
- access to all vital parts from the outside of the duct
- durable, non-flammable materials used

Fig. 1 RPM-LV without insulation



Fig. 2 RPM-LV with insulation



1.2. Specifications

- | | |
|-----------------------------------|--|
| • Function: | Control of the air flow |
| • Nominal size: | DN 80 ... DN 315 |
| • Total length: | 300 / 370 / 450 mm depending on the nominal size |
| • Length without sleeves: | 200 / 270 / 350 mm depending on the nominal size |
| • Tightness in acc. with EN 1751: | External (through the body) class C
Internal (through the damper blade) class 4 |
| • Volume air flow rates: | 9 m ³ /h ... 2244 m ³ /h, i.e. 2,5 l/s ... 623 l/s |
| • Mean air velocity in the duct: | 0,5 m/s ... 8 m/s |
| • Control pressure drop (Fig. 3): | 2 Pa ... 600 Pa |
| • Accuracy of control: | from ± 4% |

Fig. 3 Control pressure drop

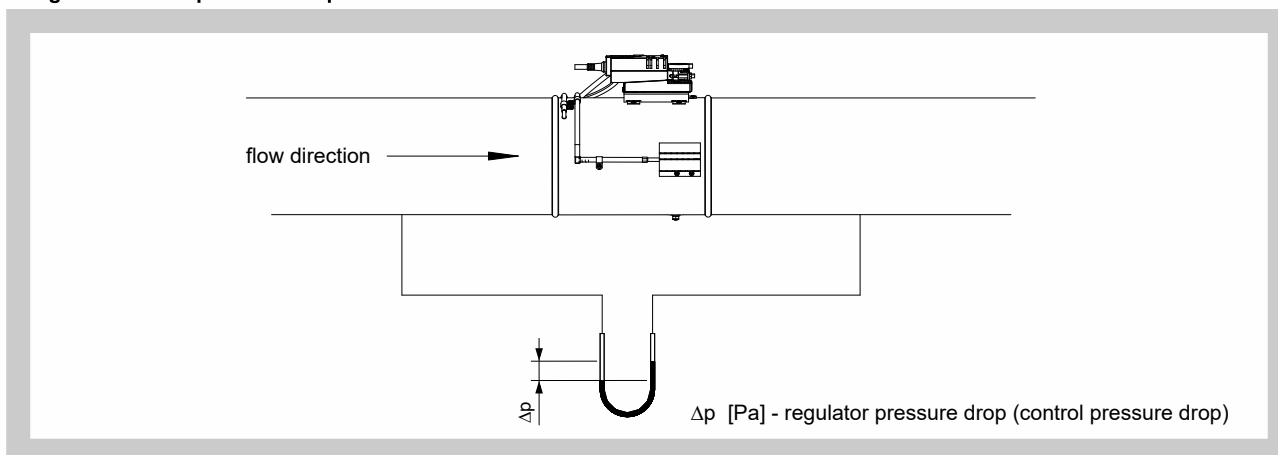

1.3. Operation conditions

To guarantee reliable functioning of air flow controllers, the following conditions shall be respected:

- a) pressure in the duct -1000 Pa (vacuum) ... +1000 Pa (overpressure)
- b) control pressure drop 2 Pa ... 600 Pa
- c) maximum mean air velocity in the duct of 8 m/s
- d) regular air velocity distribution within the cross-section of the duct
- e) mild climate 3K5 in accordance with EN 60721-3-3 rev. A2, with the absence of condensing humidity, water droplets, frost or snowflakes and other sources of water
- f) humidity 5% ... 95%
- g) absence of abrasive, adhesive, electrically charged, chemically active or radio-active particles or droplets; absence of chemically active or radio-active gases
- h) temperature range 0°C to +50°C.

2. Design

2.1. Electric components, input/output configurations, control modes, factory setup

Electric actuators are integrated with sensors, electronic controller and communication interface into one device – compact VAV controller. Electronic controller reads values from sensors, calculates actual value of the air flow rate, compares it with the requested air flow rate and commands the actuator to increase or decrease the opening of the damper as needed.

Analog and digital communication is available. Refer to Tab. 2.1.1. for the list of different configurations and setups available.

Tab. 2.1.1. Table of hardware configurations and basic software setups

Built-in compact VAV controller	Analog input / output	Digital communication	NFC wireless
BELIMO LMV-D3W-MP.1 MDK	2 to 10 V*	MP-Bus	yes
BELIMO LMV-D3W-MOD.1 MDK	2 to 10 V*	MP-Bus**, MODBUS RTU, BACnet	no

* 0 to 10 V available on demand

** advanced MP-Bus functions are not available, standard MP-Bus functions are available

Both analog and digital communication allow:

- continuous control of the air volume flow rate within \dot{V}_{min} and \dot{V}_{max}
- control in steps

Rules for \dot{V}_{min} and \dot{V}_{max} :

- \dot{V}_{max} of 20% ... 100% of \dot{V}_{nom} (\dot{V}_{nom} per size presented in par. 5.1.)
- \dot{V}_{min} of 6,25% \dot{V}_{nom} ... 100% \dot{V}_{max}

The factory will set \dot{V}_{min} and \dot{V}_{max} in accordance with customer written specification or purchase order. If no values are specified by the customer, \dot{V}_{min} will be set to minimum air flow rate and \dot{V}_{max} to maximum air flow rate presented in par. 5.1.

2.2. Duct connection style

Only connection inside circular ducts (SPIRO) with 2-lips seal available (connection style with flanges not available for this product).

2.3. Insulation

As an option, the controller may be delivered with 50 mm mineral wool insulation (shall be specified at the order).

3. Dimensions, weights

3.1. Basic dimensions and weight

Tab. 3.1.1. Basic dimensions and weight

Nominal size øD [mm]	L [mm]	M [mm]	N [mm]	O [mm]	Weight [kg]*	
					without insulation	with insulation
80	300	84	110	72	1,4	2,2
100	300	84	110	72	1,7	2,6
125	300	84	110	72	1,9	3,0
140	300	84	110	72	2,1	3,2
160	300	72	110	72	2,3	3,5
180	370	72	150	72	2,9	4,4
200	370	72	150	72	3,1	4,7
225	370	72	150	72	3,4	5,1
250	450	72	190	72	4,2	6,5
280	450	72	190	72	4,7	7,1
315	450	72	190	72	5,2	7,9

* including the weight of compact VAV controller of ca. 0,6 kg

Fig. 4 RPM-LV without insulation

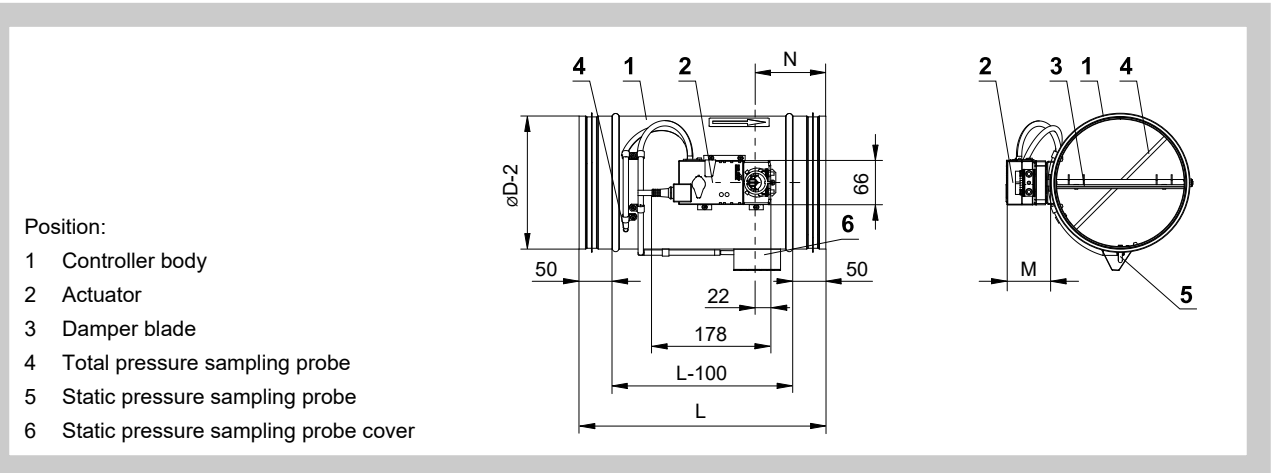
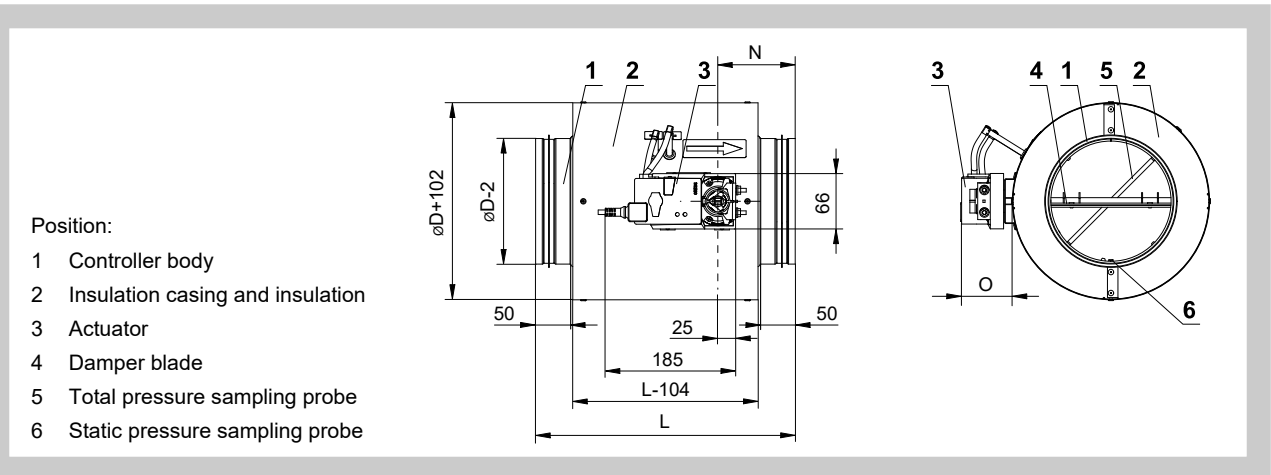

Fig. 5 RPM-LV with insulation



4. Installation in the duct

4.1. Installation in the duct

- Air flow direction is indicated by an arrow on the controller body and on Fig. 6. The indicated air direction shall be respected.
- The controller may be installed horizontally, vertically, and at any angle to the ground, cf.

Elements downstream:

- The controller may be installed in a continuous duct or form the end of the duct
- A smooth 90° (or less °) elbow may be installed directly after the controller in any direction cf. Fig. 7.

Elements upstream:

- A smooth 90° (or more open) elbow may be installed directly before the controller in directions as recommended on Fig. 8.
- Assembly of 90° elbows in a general direction and the assembly after a T-junction in general direction is recommended with 2 D length of the straight duct section where D is the nominal duct diameter.

Between 2 elbows:

- One 90° elbow downstream together with one 90° elbow upstream may be installed respecting the rules above. Several examples are shown on Fig. 9.

Fig. 6 Any physical direction possible

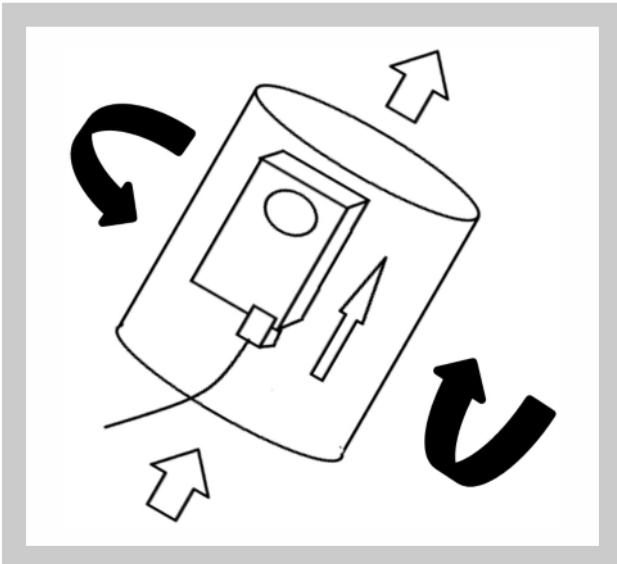

Fig. 7 Any rotation of the elbow downstream possible

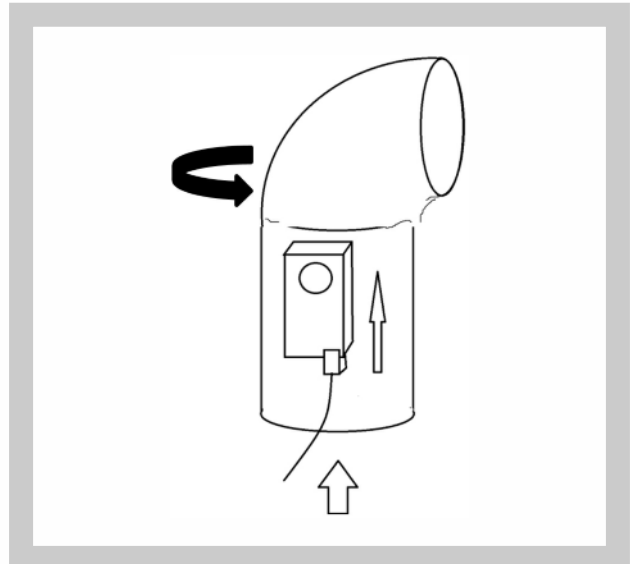

Fig. 8 Recommended positions of the elbow upstream

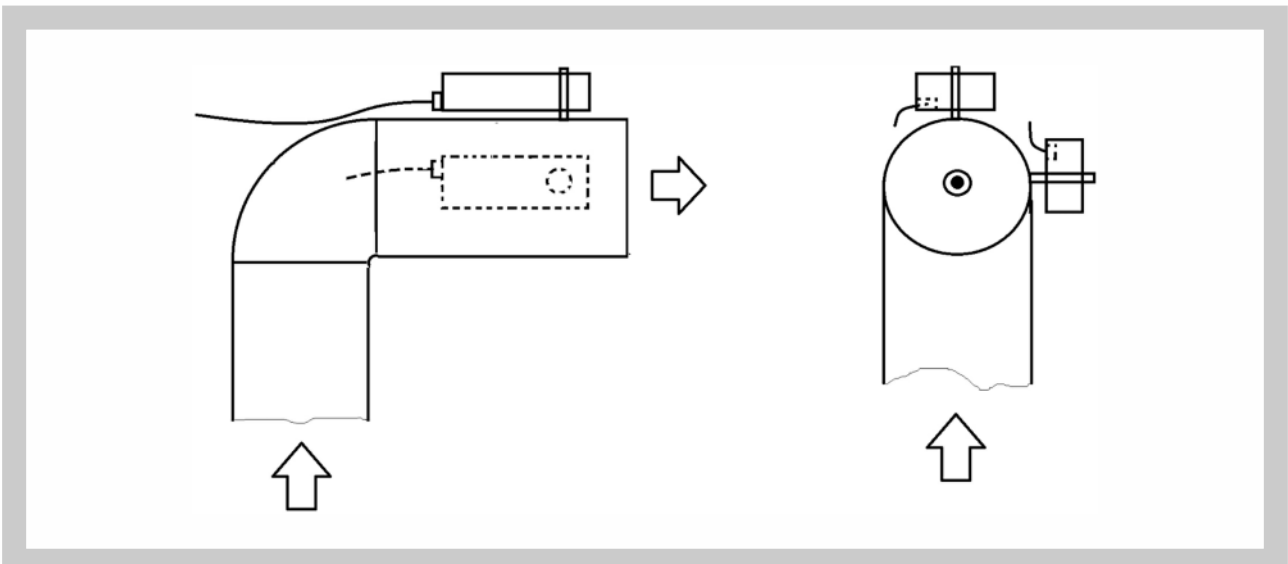
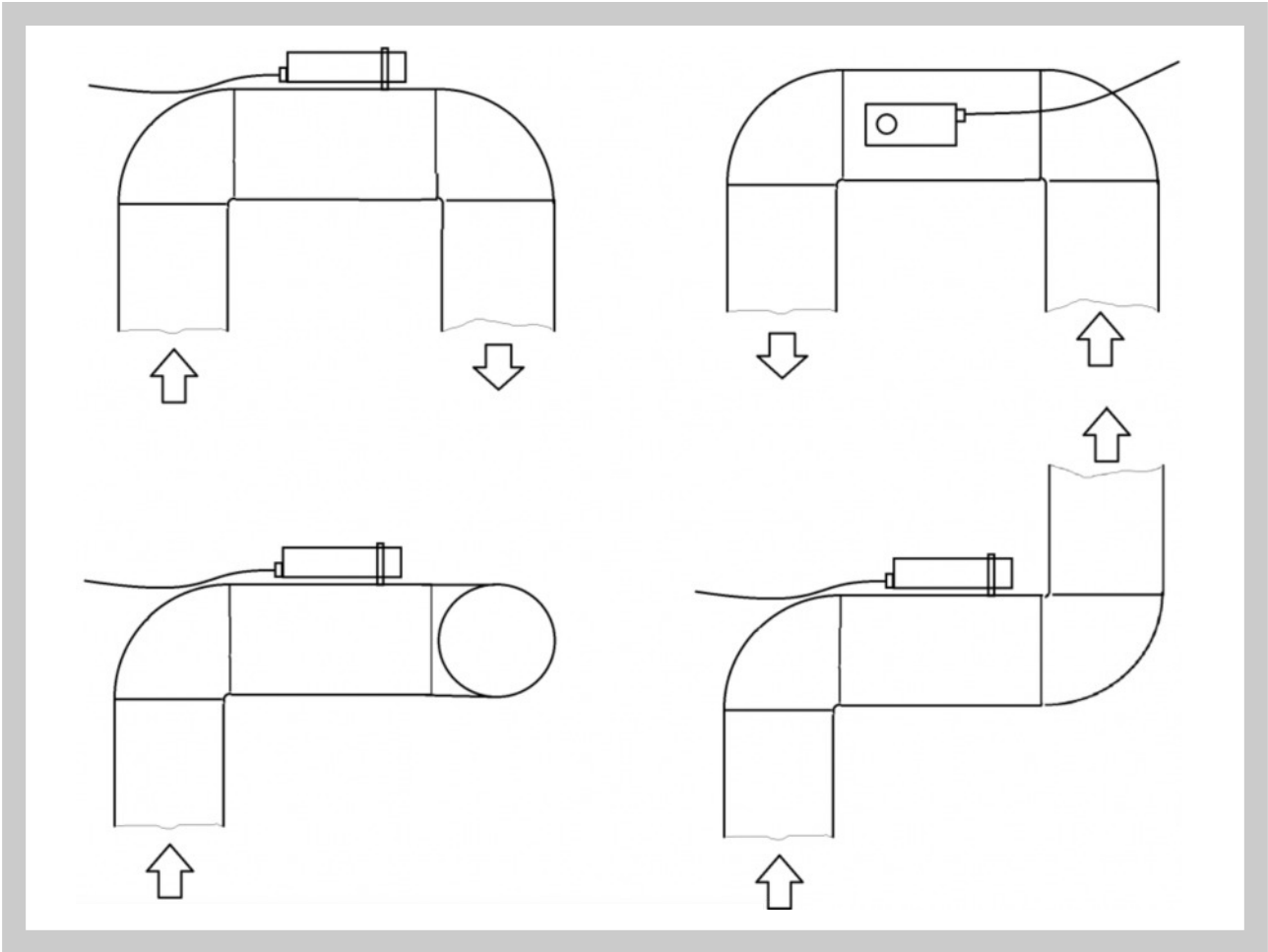

Fig. 9 Several recommended positions between 2 elbows



III. TECHNICAL DATA

5. Basic parameters

5.1. Air flow ranges

Tab. 5.1.1. Air flow ranges

Nominal Size [mm]	Minimum air flow rate		Maximum air flow rate \dot{V}_{nom}	
	[m³/h]	[l/s]	[m³/h]	[l/s]
80	9	2,5	145	40
100	14	3,9	226	63
125	22	6,1	353	98
140	28	7,7	443	123
160	36	10	579	161
180	46	13	733	204
200	57	16	905	251
225	72	20	1145	318
250	88	25	1414	393
280	111	31	1773	493
315	140	39	2244	623
w [m/s]*	0,5		8	

* mean air velocity in the duct

5.2. Accuracy of control

Accuracy for low velocities is determined mostly by the gear play of the actuators. Accuracy at low control pressure drops is impacted by the accuracy of pressure sensors making part of VAV compact controllers. State of the art actuators and pressure sensors are used.

Graph 1 Accuracy of control for control pressure drops of 10 Pa ... 600 Pa

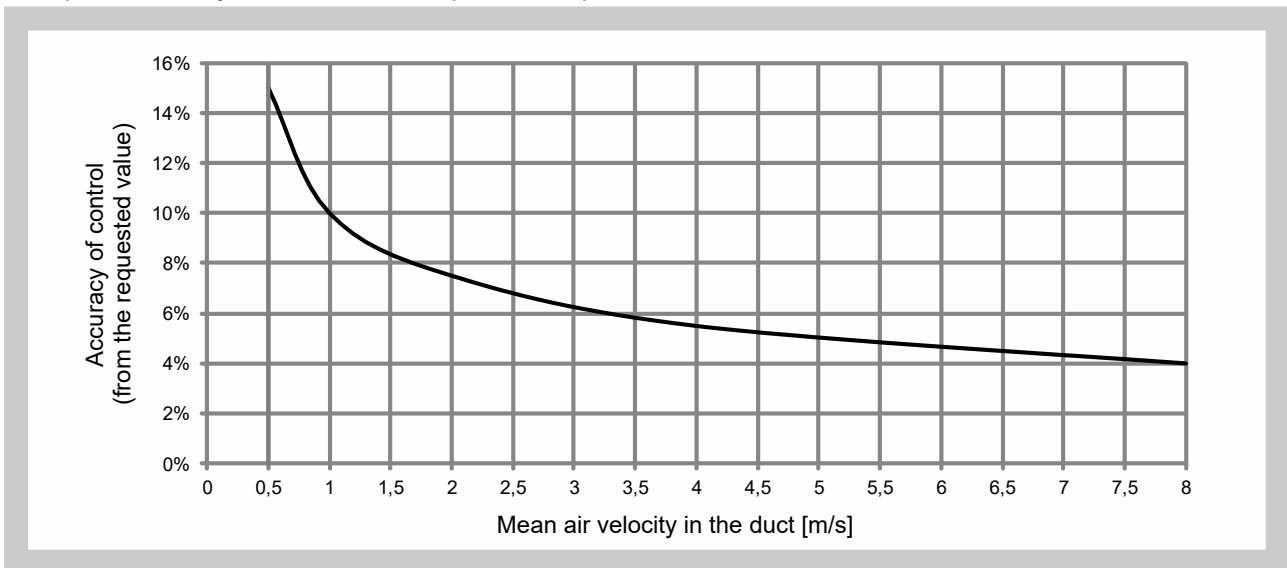

Graph 2 Accuracy of control correction for extremely small control pressure drops

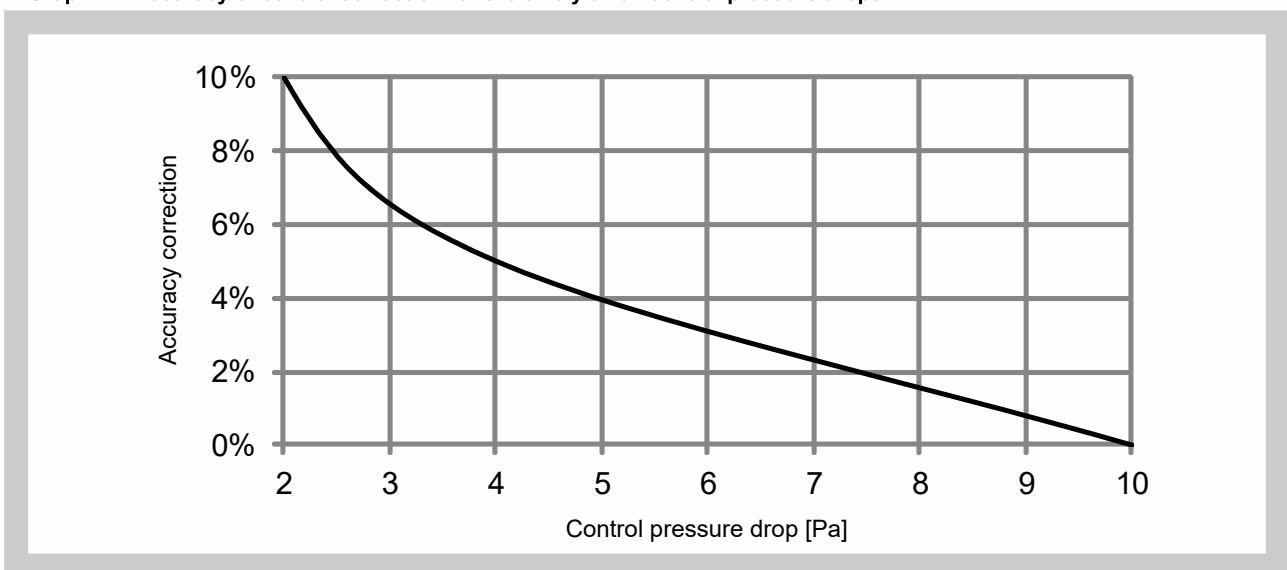

5.3. Controllers installed with the elbow directly upstream (without 2D straight duct) as per Fig 8 and 9 control with systematic error of about -5% in average. On demand, the Factory may program the controller with correction curve fully eliminating such error within the full range of operating conditions. Such a request must be specified at the order.

6. Electric parameters

6.1. Electric parameters of BELIMO actuator

Tab. 6.1.1. Electric parameters of BELIMO actuator LMV-D3W-MP.1 MDK a LMV-D3W-MOD.1 MDK

Actuator BELIMO		LMV-D3W-MP.1 MDK compact VAV controller LMV-D3W-MOD.1 MDK compact VAV controller
Power supply	Supply voltage	24 V AC 50/60 Hz
	Range of supply voltage	AC 19,2 ... 28,8 V DC 21,6 ... 28,8 V
	Dimensioning	4 VA (max 8 A @ 5 ms)
	Power supply – motion	2 W
	Power supply – motor idle	1 W
Analog input Y	Requested air flow (and damper closed command ⁴⁾)	DC 2 ... 10 V ³⁾¹⁾ or DC 0 ... 10 V ²⁾ (R _i ≥ 100 kΩ)
	Control in steps	24 V AC from the supply
Analog output U	Actual air flow ³⁾ / Damper position ⁵⁾	DC 2 ... 10 V ³⁾ or DC 0 ... 10 V (max 0,5 mA)
Connection	LMV-D3W-MP.1 MDK	1 m kabel 4 x 0,75 mm ²
	LMV-D3W-MOD.1 MDK	1 m kabel 6 x 0,75 mm ²
Protection category		III (safety extra-low voltage)

- 1) The signal may be eventually obtained from 2 ... 20 mA signal on external measuring 500 Ω resistor.
- 2) The signal may be eventually obtained from 0 ... 20 mA signal on external measuring 500 Ω resistor.
- 3) Standard.
- 4) For 2 ... 10 V only
- 5) Shall be specified at the order.

6.2. Wiring diagrams

Fig. 10 Controller with BELIMO compact VAV controller LMV-D3W-MP.1 MDK

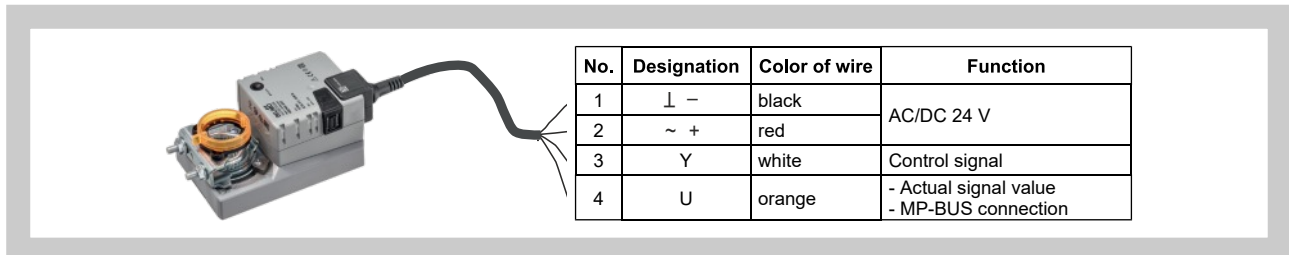

Fig. 11 Air flow control with actuator LMV-D3W-MP.1 MDK

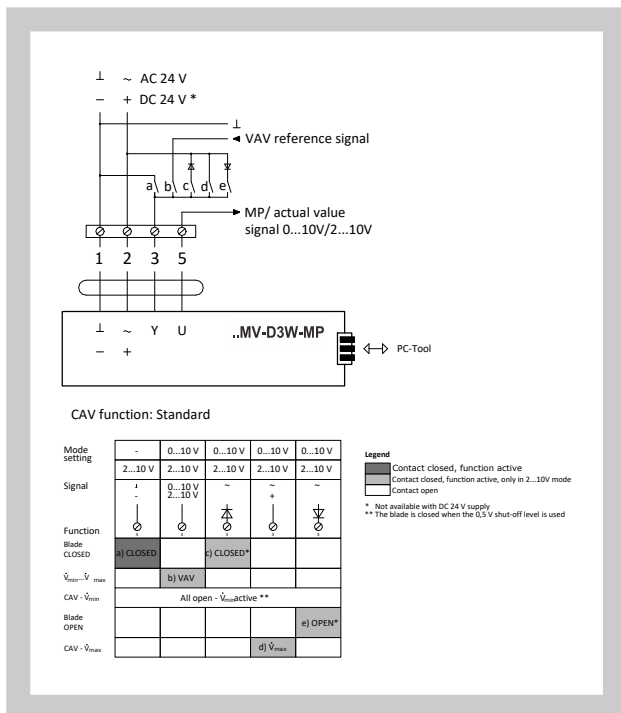

Fig. 12 Master-slave flow control with actuators LMV-D3W-MP.1 MDK

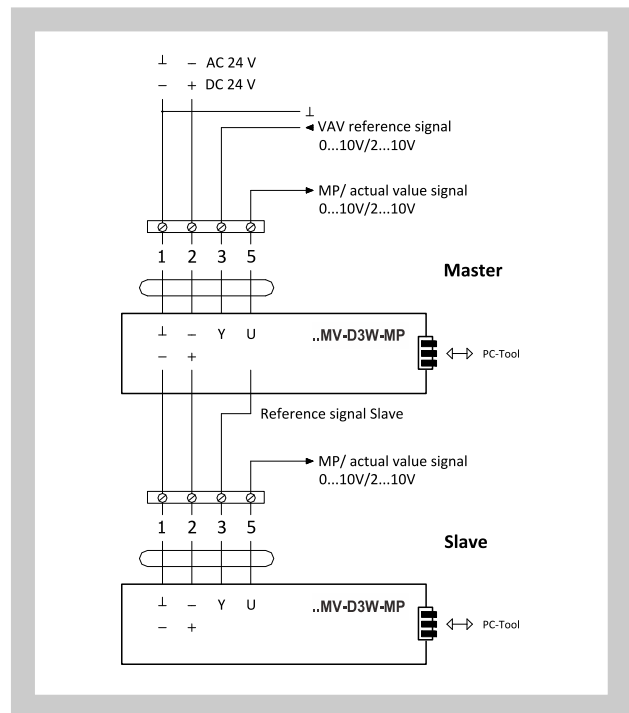

Fig. 13 Controller with BELIMO compact VAV controller LMV-D3W-MOD.1 MDK

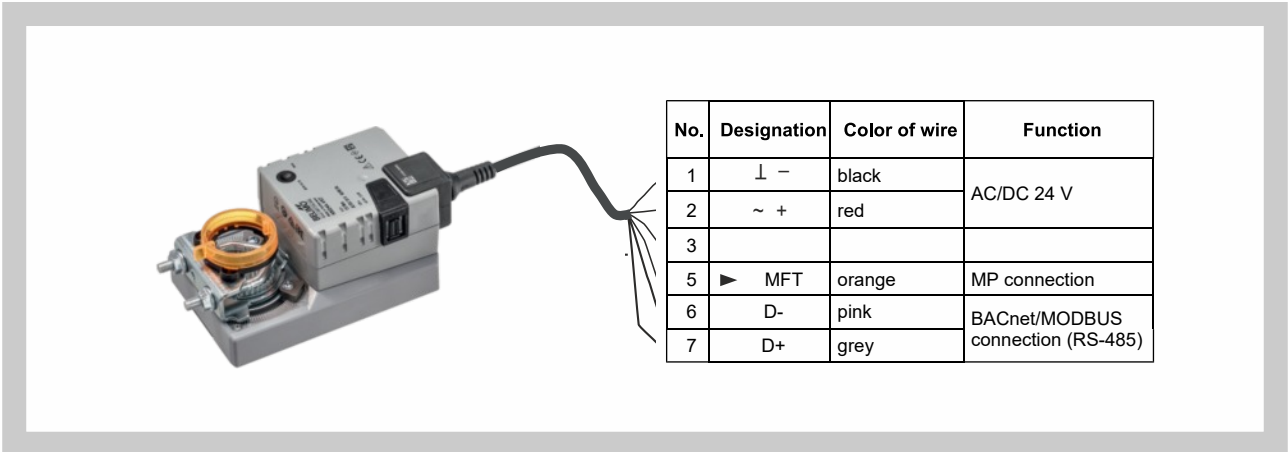
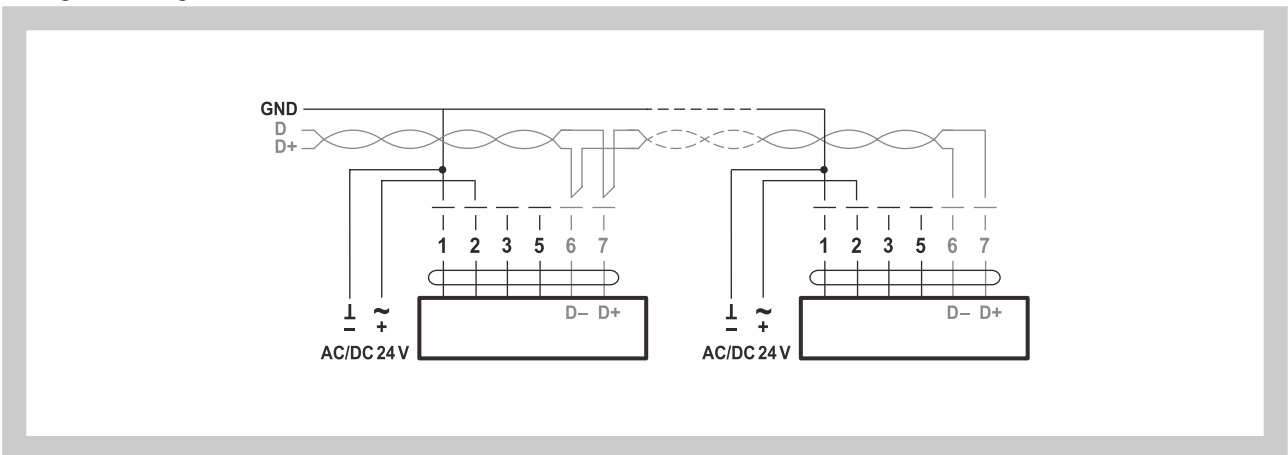

Fig. 14 Wiring of LMV-D3W-MOD.1 MDK on the serial line RS-485



7. Determination of actual air volume

7.1. Calculation of actual air flow rate, setting of the requested flow rate U.

Sample for the operating mode 0 ... 10 V

$$\dot{V} = \frac{U \cdot \dot{V}_{nom}}{10}$$

Sample for the operating mode 2 ... 10 V

$$\dot{V} = \frac{U - 2,0}{8} \cdot \dot{V}_{nom}$$

Example: Operating mode 0 ... 10 V

Searched for: actual air volume
Voltage measured on U : 3,5 V
 $\dot{V}_{nom} = 2244 \text{ m}^3/\text{h}$

$$\dot{V} = \frac{3,5 \cdot 2244}{10} = 785$$

Actual air volume is 785 m³/h

Fig. 15 Determination of the actual value of U by means of a voltage meter

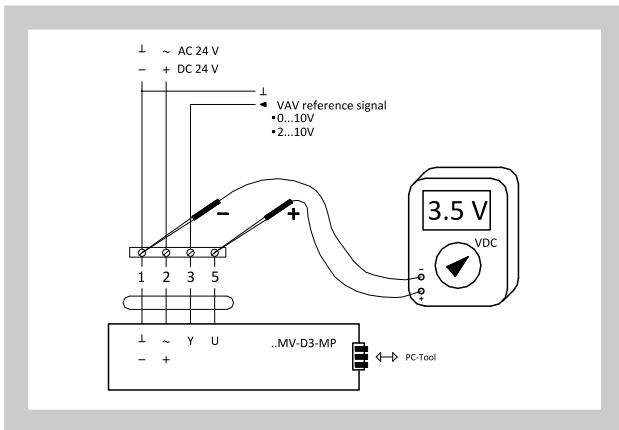

Example: Operating mode 2 ... 10 V

Searched for: actual air volume
Voltage measured on U : 3,5 V
 $\dot{V}_{nom} = 579 \text{ m}^3/\text{h}$

$$\dot{V} = \frac{3,5 - 2,0}{8} \cdot 579 = 109$$

Actual air volume is 109 m³/h

7.2. Similarly, requested air flow rate should be transferred into Y signal where 2(0) V corresponds to \dot{V}_{min} and 10 V corresponds to \dot{V}_{max}

All air flow rates and velocities in the duct are considered with standard air density of 1,2 kg/m³ through this Technical Specifications

8. Pressure drop

8.1. Pressure drop

Diagram 8.1.1. Pressure drop (the values are valid when the damper of the controller is completely open)

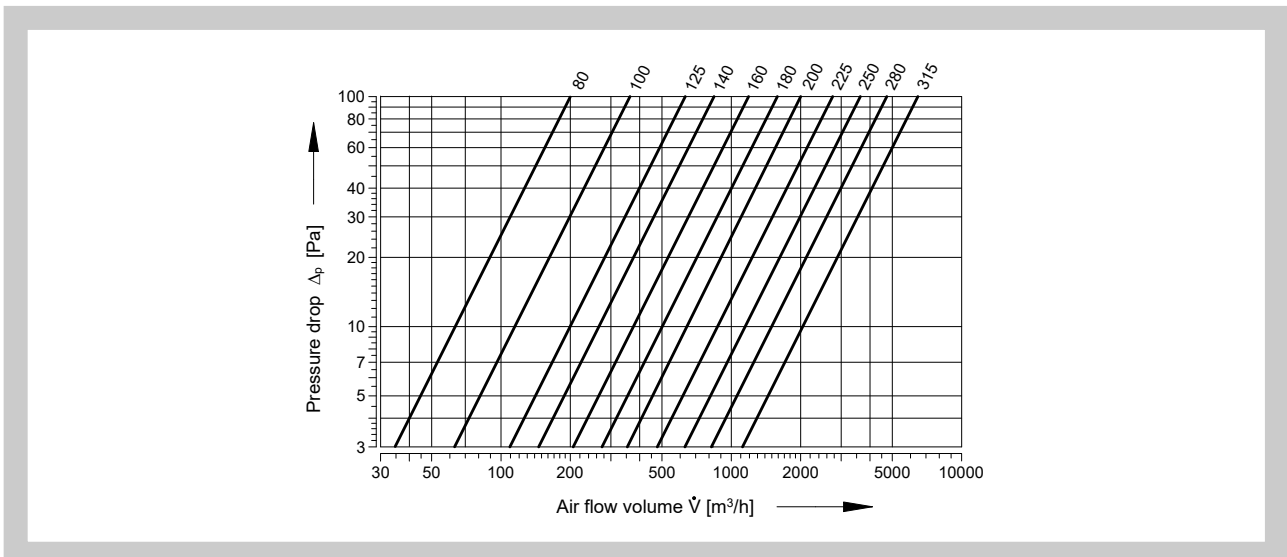

9. Noise data

9.1. Aerodynamic noise

The noise arising due to the flow of air volume controller is listed in the following tables Tab. 9.1.1. to Tab. 9.1.4.

- \dot{V} [m³/h] - air flow volume
- Δp_{st} [Pa] - pressure differential
- L_w [dB/Okt.] - level of acoustic power in the octave band
- L_{WA} [dB(A)] - total level of acoustic power corrected by filter A
- f_m [Hz] - mean frequencies in the octave bands

Tab. 9.1.1. Sound power level inside the pipeline at pressure difference 50 Pa

Nominal Size [mm]	\dot{V} [m ³ /h]	$\Delta p_{st} = 50 \text{ Pa}$									L_{WA} [dB(A)]
		L_w [dB/Okt]									
		f_m [Hz]									
		63	125	250	500	1000	2000	4000	8000		
80	9	39	30	24	24	27	24	16	6	30	
	72	51	41	35	35	38	34	27	26	41	
	145	56	46	40	40	43	40	33	21	46	
	217	61	51	45	45	48	45	36	25	51	
100	14	41	32	26	26	29	25	18	8	32	
	113	52	42	39	39	36	34	35	18	42	
	226	61	54	50	50	45	46	38	25	52	
	339	68	62	58	58	50	52	40	29	59	
125	22	43	33	27	27	30	27	19	9	33	
	177	57	48	44	41	42	39	32	22	46	
	353	63	55	51	47	46	42	39	27	51	
	530	70	62	58	53	50	42	43	33	56	
140	28	44	35	29	29	32	28	20	11	35	
	222	57	48	45	41	39	36	32	21	45	
	443	62	55	51	47	46	42	38	26	51	
	665	70	62	58	53	50	46	43	33	56	
160	36	46	37	31	31	34	30	22	12	37	
	290	58	49	45	42	44	39	32	22	47	
	579	65	57	53	49	48	44	39	29	53	
	869	71	64	60	56	53	48	44	33	59	
180	46	46	36	31	31	34	30	22	12	37	
	336	58	49	45	43	43	40	33	21	47	
	733	64	56	53	49	58	44	40	28	53	
	1099	72	64	60	55	52	48	45	34	58	
200	57	46	36	31	31	34	31	23	12	37	
	452	58	49	45	43	44	40	33	22	47	
	905	66	58	54	50	49	45	41	30	54	
	1357	73	65	61	56	54	49	43	36	59	
225	72	48	38	32	32	35	31	26	14	38	
	573	57	48	44	41	42	40	33	21	46	
	1145	65	57	53	50	48	45	40	29	53	
	1718	73	65	61	57	54	50	47	35	60	
250	88	48	37	33	33	34	32	24	13	38	
	707	58	50	46	43	44	42	33	24	48	
	1414	65	59	55	51	49	46	41	29	54	
	2121	72	64	61	56	53	50	46	34	59	
280	111	49	39	33	33	36	32	25	14	39	
	887	60	51	48	44	45	42	35	23	49	
	1773	66	59	55	51	50	46	42	30	55	
	2660	74	66	62	57	53	47	45	35	60	
315	140	48	54	32	32	24	31	24	14	40	
	1122	60	52	47	44	45	41	44	24	50	
	2244	68	60	56	52	51	47	43	31	56	
	3367	76	68	64	59	56	52	48	37	62	

Tab. 9.1.2. Sound power level inside the pipeline at pressure difference 100 Pa

Nominal Size [mm]	\dot{V} [m³/h]	$\Delta p_{st} = 100 \text{ Pa}$								
		L_w [dB/Okt]								L_{WA} [dB(A)]
		f_m [Hz]								
		63	125	250	500	1000	2000	4000	8000	
80	9	46	36	30	30	33	29	20	9	36
	72	57	47	41	41	43	39	30	18	46
	145	61	51	45	45	47	44	35	24	51
	217	66	55	51	51	53	49	40	28	56
100	14	47	37	31	31	34	30	22	10	37
	113	59	49	45	45	42	39	33	21	47
	226	67	59	56	56	50	46	42	30	57
	339	73	66	64	64	55	51	47	33	64
125	22	49	39	33	33	36	32	23	11	39
	177	63	54	50	48	47	43	36	25	51
	353	68	60	56	52	51	47	42	30	56
	530	74	66	62	57	54	50	46	35	60
140	28	50	40	34	34	37	33	25	13	40
	222	61	52	48	45	46	42	35	24	50
	443	68	60	56	52	51	47	43	30	56
	665	75	67	63	58	55	51	48	37	61
160	36	52	42	36	36	39	35	27	15	42
	290	63	54	50	47	48	44	37	26	52
	579	70	62	58	54	53	49	44	32	58
	869	77	69	65	60	57	53	50	48	63
180	46	54	44	38	38	41	37	29	17	44
	336	63	54	50	47	48	45	37	26	52
	733	70	62	58	54	53	49	45	32	58
	1099	77	69	65	60	57	53	50	38	63
200	57	54	44	38	38	41	37	28	16	44
	452	64	55	51	48	49	45	38	26	53
	905	71	63	59	55	54	50	46	33	59
	1357	78	70	66	62	58	54	50	40	64
225	72	54	44	38	38	41	36	28	16	44
	573	63	55	50	48	48	45	36	26	52
	1145	70	62	59	55	53	50	46	33	58
	1718	78	70	66	61	58	54	50	39	64
250	88	52	44	38	38	41	37	29	17	44
	707	64	55	51	48	49	46	38	27	53
	1414	70	62	58	55	54	49	45	32	58
	2121	77	69	65	60	57	53	50	38	63
280	111	55	45	39	39	42	37	30	18	45
	887	75	56	52	48	49	46	39	28	54
	1773	71	63	59	55	54	50	46	34	59
	2660	78	70	66	61	58	54	51	49	64
315	140	56	46	40	40	43	39	30	19	46
	1122	66	57	54	51	51	48	40	29	55
	2244	73	65	61	57	56	52	48	35	61
	3367	80	72	68	63	60	56	53	41	66

Tab. 9.1.3. Sound power level inside the pipeline at pressure difference 250 Pa

Nominal Size [mm]	\dot{V} [m³/h]	$\Delta p_{st} = 250 \text{ Pa}$								
		L_w [dB/Okt]								L_{WA} [dB(A)]
		f_m [Hz]								
		63	125	250	500	1000	2000	4000	8000	
80	9	53	43	37	37	40	35	26	14	43
	72	63	53	47	48	50	47	39	26	53
	145	68	58	53	53	54	52	43	30	58
	217	73	62	57	57	60	56	47	35	63
100	14	55	46	39	39	42	38	30	18	45
	113	65	57	53	53	50	48	39	29	55
	226	73	66	62	62	58	52	48	36	63
	339	81	73	69	70	62	57	54	43	70
125	22	58	48	42	42	45	41	32	20	48
	177	68	59	56	53	54	49	43	32	58
	353	75	67	63	59	58	53	48	36	63
	530	81	73	69	63	60	56	53	41	67
140	28	59	49	43	43	45	42	34	22	49
	222	69	60	56	53	54	50	43	33	58
	443	75	67	63	59	58	54	50	38	63
	665	81	73	69	64	61	57	54	43	67
160	36	61	51	45	45	48	44	36	24	51
	290	71	62	58	55	56	52	45	33	60
	579	77	69	65	61	60	56	51	39	65
	869	83	75	71	66	63	59	55	44	69
180	46	63	53	47	47	50	45	37	25	53
	336	70	62	59	56	55	52	44	33	60
	733	76	69	65	61	60	55	50	38	65
	1099	81	74	71	66	62	58	54	43	69
200	57	63	53	47	47	50	46	38	25	53
	452	72	63	59	56	57	53	46	35	61
	905	77	70	66	62	61	57	52	40	66
	1357	83	75	71	67	63	59	56	44	70
225	72	63	53	47	47	50	47	39	26	53
	573	70	61	56	54	55	51	43	33	59
	1145	76	68	65	60	59	56	52	39	64
	1718	73	75	72	66	62	59	56	45	69
250	88	64	54	47	47	50	47	39	27	53
	707	71	62	59	55	56	53	45	34	60
	1414	77	69	65	61	60	56	52	40	65
	2121	83	75	71	66	63	59	56	45	69
280	111	64	54	48	48	51	47	40	28	54
	887	72	64	60	56	58	53	46	34	61
	1773	78	70	66	62	61	57	52	40	66
	2660	84	76	72	67	65	59	58	46	70
315	140	64	54	48	48	51	48	39	26	54
	1122	74	65	61	58	59	55	48	36	63
	2244	80	72	68	64	63	59	55	42	68
	3367	86	78	74	69	66	62	59	48	72

Tab. 9.1.4. Sound power level inside the pipeline at pressure difference 500 Pa

Nominal Size [mm]	\dot{V} [m ³ /h]	$\Delta p_{st} = 500 \text{ Pa}$								
		L_w [dB/Okt]								L_{WA} [dB(A)]
		f_m [Hz]								
		63	125	250	500	1000	2000	4000	8000	
80	9	61	51	45	45	48	44	34	23	51
	72	71	61	55	55	57	56	47	34	61
	145	76	67	60	60	63	59	50	38	66
	217	79	70	64	64	67	63	55	43	70
100	14	62	53	46	46	49	46	38	26	52
	113	71	62	59	59	57	53	46	35	61
	226	80	73	68	68	64	60	55	43	69
	339	87	80	76	76	68	64	60	49	76
125	22	66	56	60	60	53	49	40	28	56
	177	76	67	63	59	61	46	48	37	64
	353	81	73	69	65	64	61	56	44	69
	530	87	79	75	70	67	64	60	49	73
140	28	67	57	51	51	54	50	41	29	57
	222	75	66	62	59	61	56	49	38	64
	443	77	72	69	64	63	59	55	44	68
	665	86	78	74	69	66	62	60	49	72
160	36	68	58	52	52	55	51	43	30	58
	290	78	69	65	62	63	60	52	41	67
	579	83	75	71	68	66	62	59	46	71
	869	89	81	77	72	69	65	61	50	75
180	46	70	60	54	54	57	53	45	32	60
	336	78	69	64	62	62	59	52	41	66
	733	83	75	71	67	67	63	59	46	71
	1099	90	81	77	72	69	65	63	51	75
200	57	70	61	55	55	58	54	46	33	61
	452	78	69	65	62	63	60	53	41	67
	905	83	75	71	68	66	63	59	46	71
	1357	90	81	78	72	69	65	60	51	75
225	72	70	60	55	54	57	54	46	33	60
	573	77	68	63	61	61	58	51	40	65
	1145	82	74	71	67	65	62	58	45	70
	1718	88	80	76	71	68	65	61	50	74
250	88	72	62	55	55	58	55	47	34	61
	707	78	69	65	62	63	59	52	40	67
	1414	83	75	71	67	66	62	58	45	71
	2121	89	81	77	72	69	65	61	50	75
280	111	71	61	55	55	58	54	47	35	61
	887	79	70	65	63	63	60	53	42	67
	1773	83	75	71	68	66	62	59	45	71
	2660	89	81	77	73	69	65	61	50	75
315	140	74	64	58	58	61	57	49	36	64
	1122	81	72	68	65	66	63	56	44	70
	2244	85	78	74	70	69	64	61	48	74
	3367	91	83	79	74	71	67	63	51	77

Graph 3 Sound power level L_{WA} [dB(A)] inside the pipeline DN80

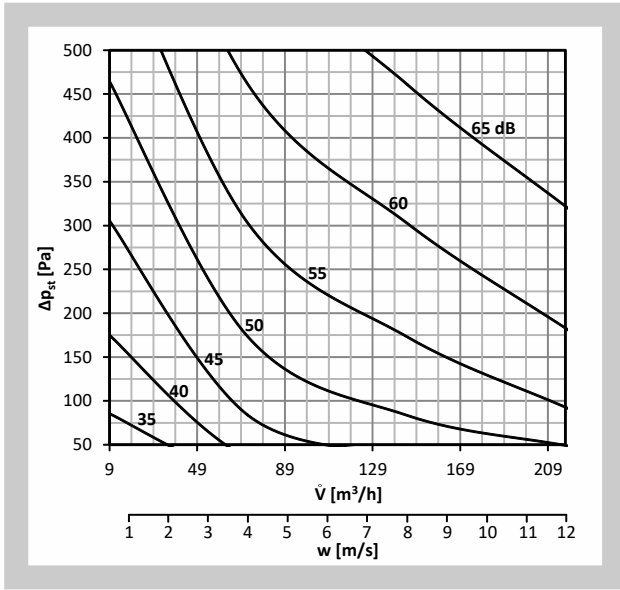

Graph 4 Sound power level L_{WA} [dB(A)] inside the pipeline DN100

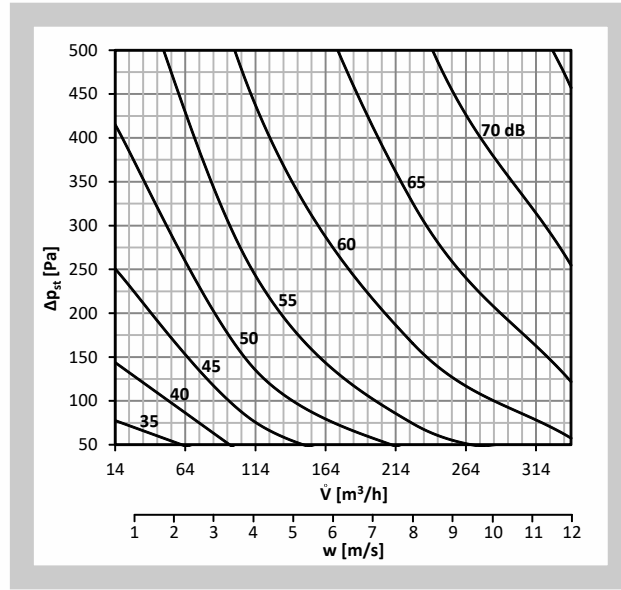

Graph 4 Sound power level L_{WA} [dB(A)] inside the pipeline DN125

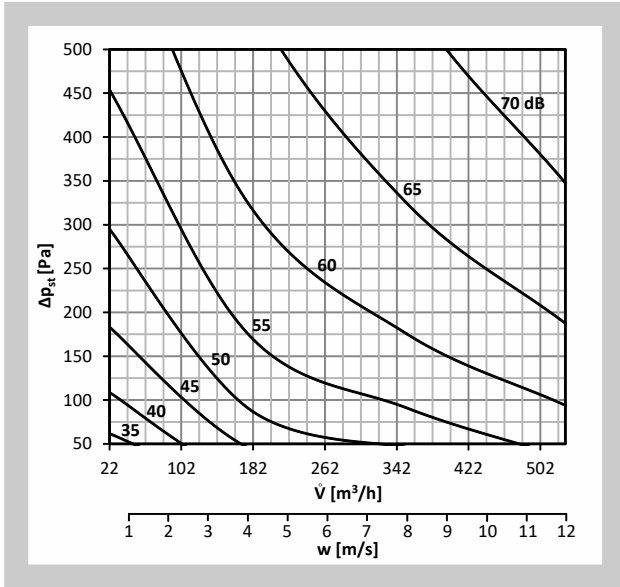

Graph 6 Sound power level L_{WA} [dB(A)] inside the pipeline DN140

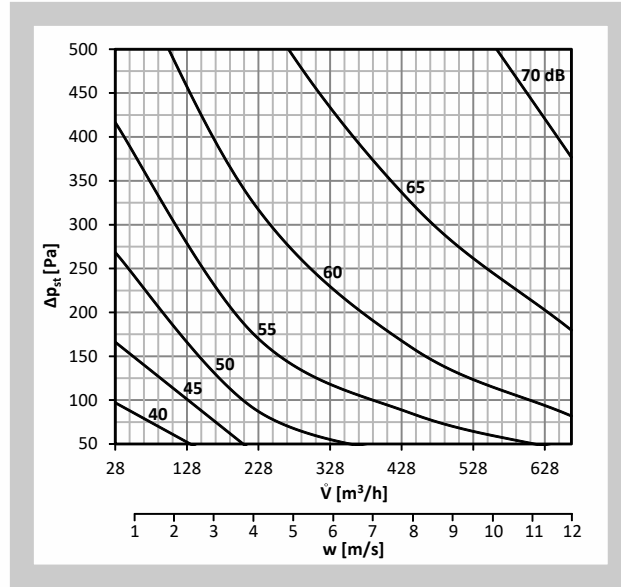

Graph 7 Sound power level L_{WA} [dB(A)] inside the pipeline DN160

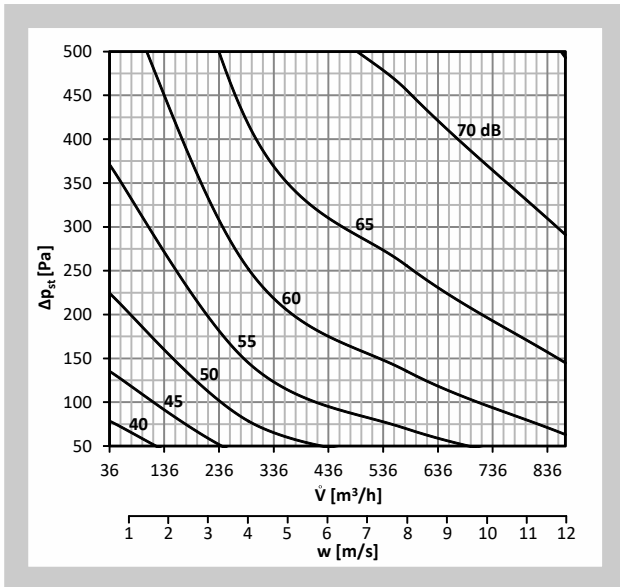

Graph 8 Sound power level L_{WA} [dB(A)] inside the pipeline DN180

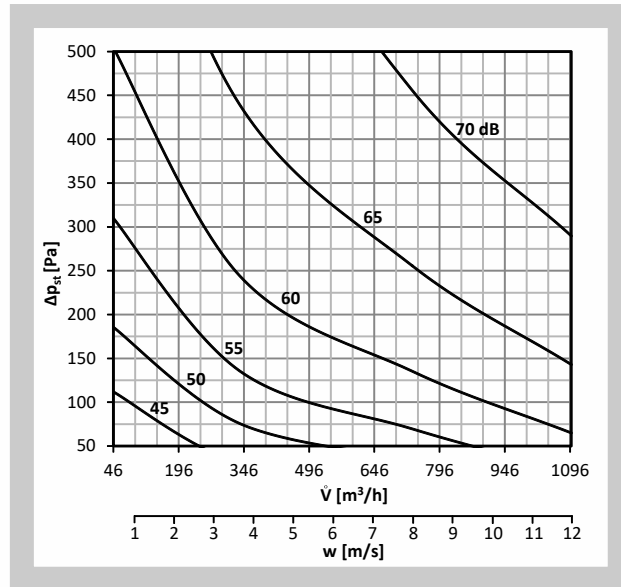

Graph 9 Sound power level L_{WA} [dB(A)] inside the pipeline DN200

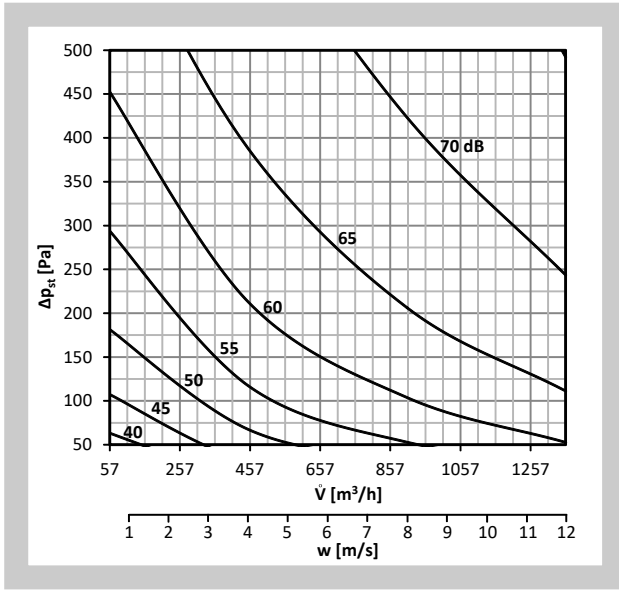

Graph 10 Sound power level L_{WA} [dB(A)] inside the pipeline DN225

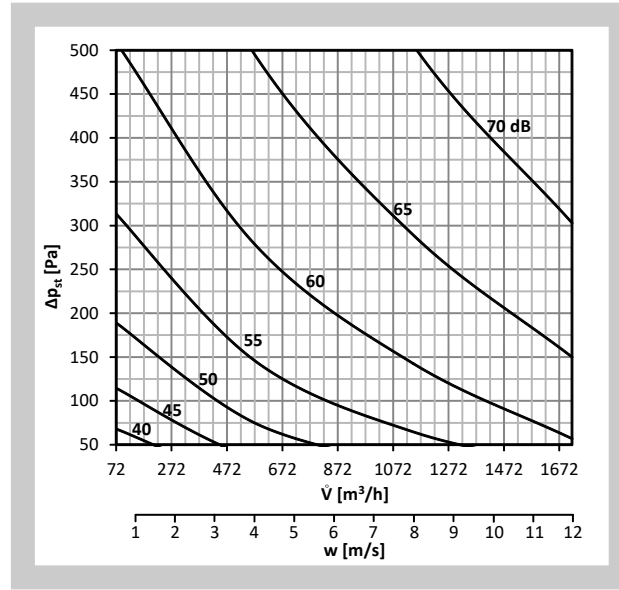

Graph 11 Sound power level L_{WA} [dB(A)] inside the pipeline DN250

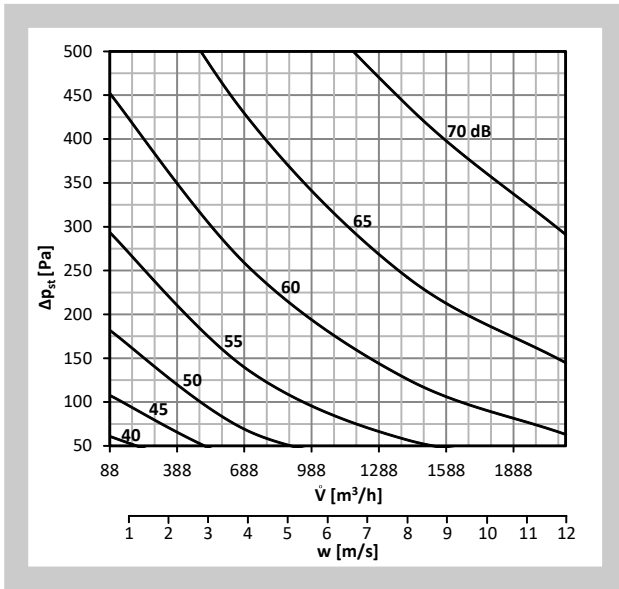

Graph 12 Sound power level L_{WA} [dB(A)] inside the pipeline DN280

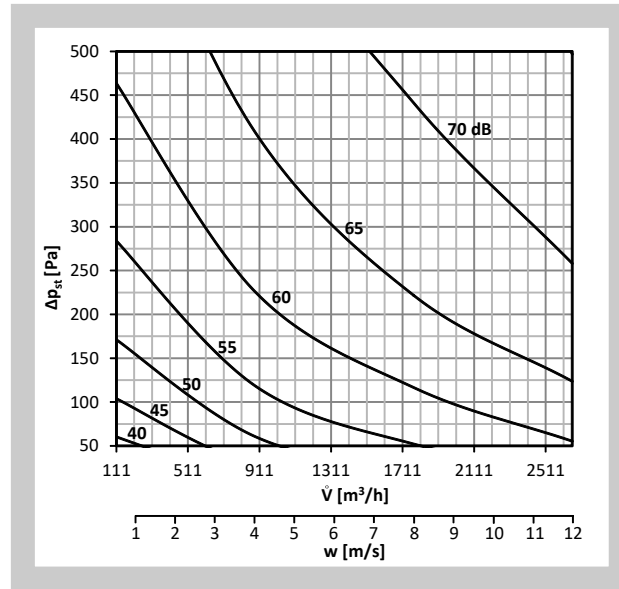

Graph 13 Sound power level L_{WA} [dB(A)] inside the pipeline DN315

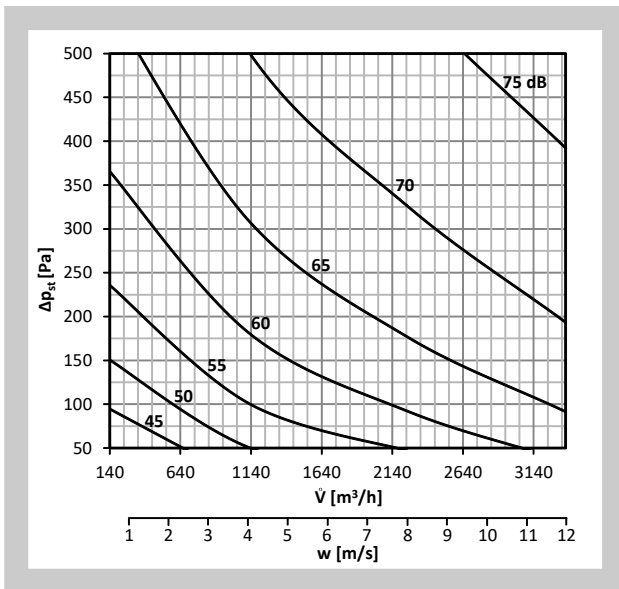

9.2. Radiated noise - without insulation

The radiated noise of air volume controller is listed in Tab. 9.2.1.

\dot{V} [m³/h] - air flow volume

L_{WA} [dB(A)] - total level of acoustic power corrected by filter A

Δp_{st} [Pa] - control pressure drop

Tab. 9.2.1. Sound power level radiated outside the pipeline - without insulation

Nominal Size [mm]	\dot{V} [m ³ /h]	L_{WA} [dB(A)]	L_{WA} [dB(A)]	L_{WA} [dB(A)]	L_{WA} [dB(A)]
		$\Delta p_{st} = 50$ Pa	$\Delta p_{st} = 100$ Pa	$\Delta p_{st} = 250$ Pa	$\Delta p_{st} = 500$ Pa
80	9	<15	16	24	33
	72	22	27	35	43
	145	29	33	41	49
	217	35	39	46	54
100	14	<15	17	26	36
	113	23	28	36	44
	226	30	35	42	49
	339	35	40	47	54
125	22	<15	19	28	38
	177	25	31	39	47
	353	32	37	44	51
	530	36	41	48	55
140	28	17	22	30	39
	222	27	32	39	47
	443	33	38	45	52
	665	39	43	50	56
160	36	20	25	33	41
	290	28	33	41	48
	579	33	38	46	53
	869	38	43	50	57
180	46	19	24	32	40
	336	29	34	42	49
	733	34	39	47	54
	1099	39	44	51	57
200	57	20	25	33	41
	452	29	34	42	49
	905	34	39	47	53
	1357	40	44	51	57
225	72	21	26	36	44
	573	31	36	44	51
	1145	36	41	48	55
	1718	41	45	52	58
250	88	24	29	38	46
	707	34	38	45	52
	1414	39	43	49	56
	2121	43	47	53	59
280	111	27	32	42	50
	887	35	41	49	55
	1773	40	45	53	59
	2660	44	49	56	62
315	140	29	34	44	52
	1122	37	42	50	57
	2244	41	46	54	60
	3367	46	50	58	64

Graph 14 Sound power level LWA [dB(A)] radiated outside the pipeline DN80, without insulation

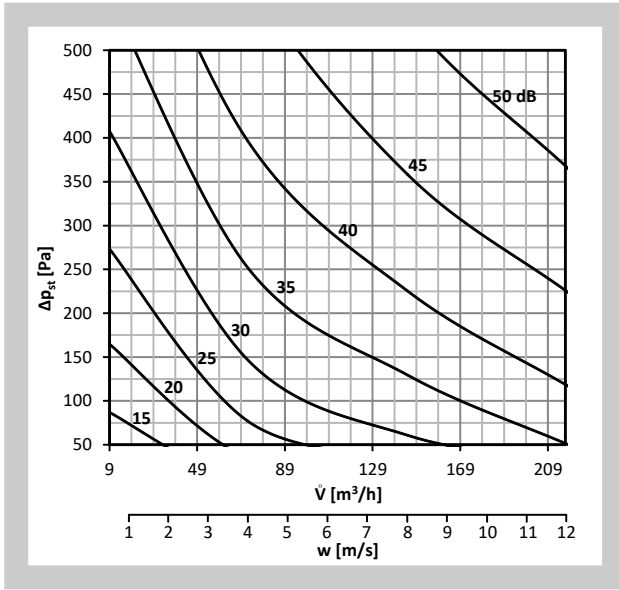

Graph 15 Sound power level LWA [dB(A)] radiated outside the pipeline DN100, without insulation

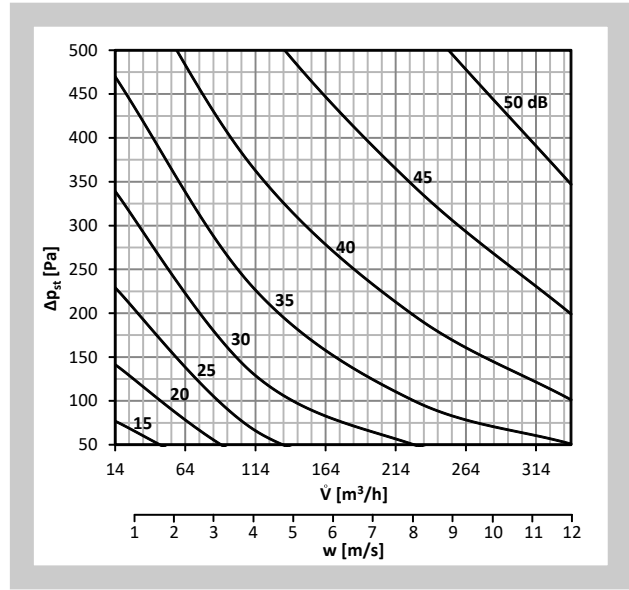

Graph 16 Sound power level LWA [dB(A)] radiated outside the pipeline DN125, without insulation

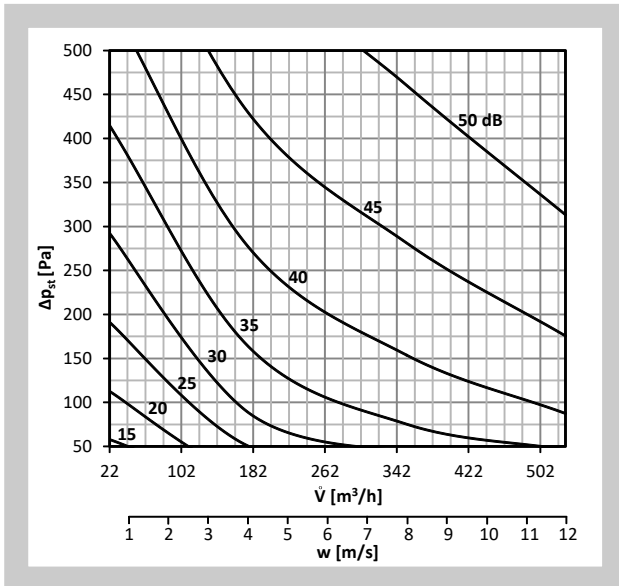

Graph 17 Sound power level LWA [dB(A)] radiated outside the pipeline DN140, without insulation

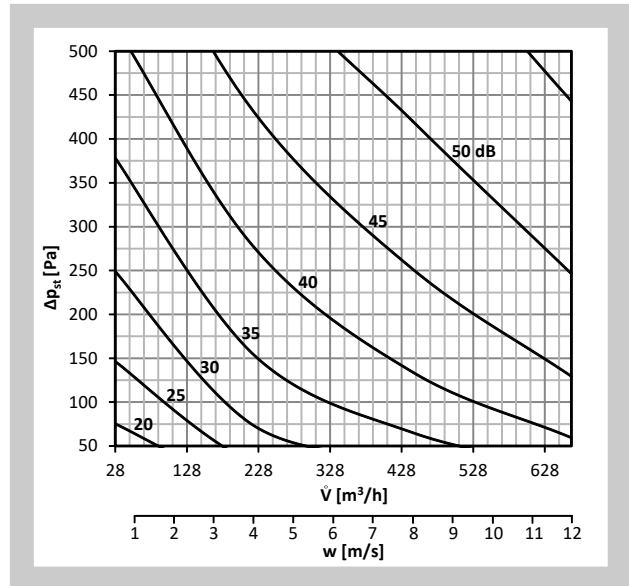

Graph 18 Sound power level LWA [dB(A)] radiated outside the pipeline DN160, without insulation

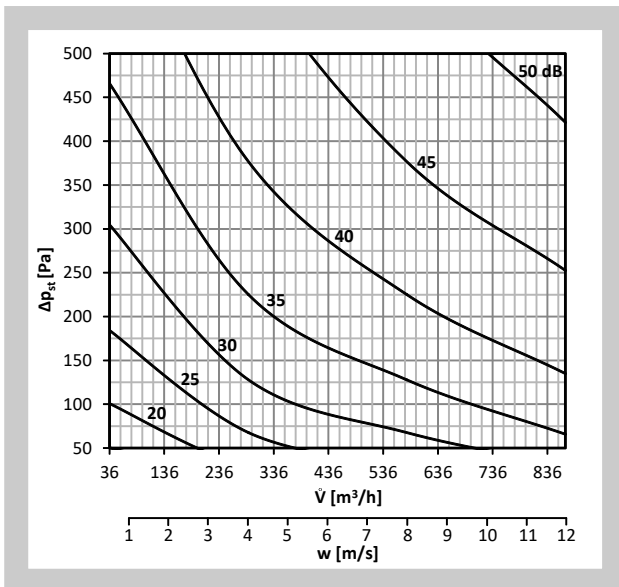

Graph 19 Sound power level LWA [dB(A)] radiated outside the pipeline DN180, without insulation

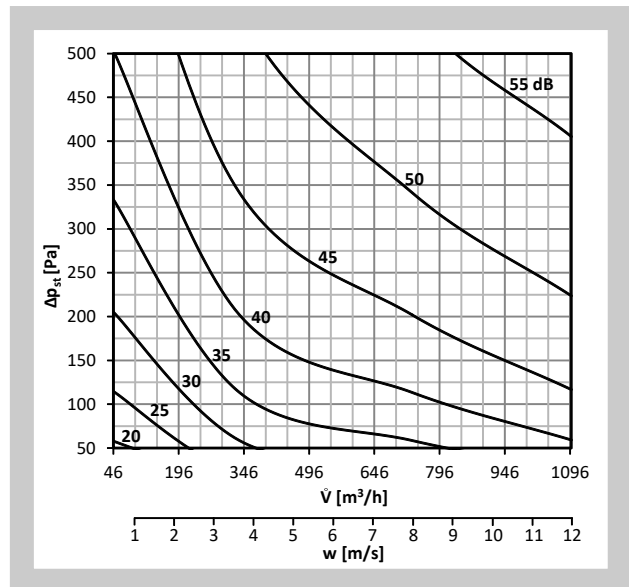

Graph 20 Sound power level LWA [dB(A)] radiated outside the pipeline DN200, without insulation

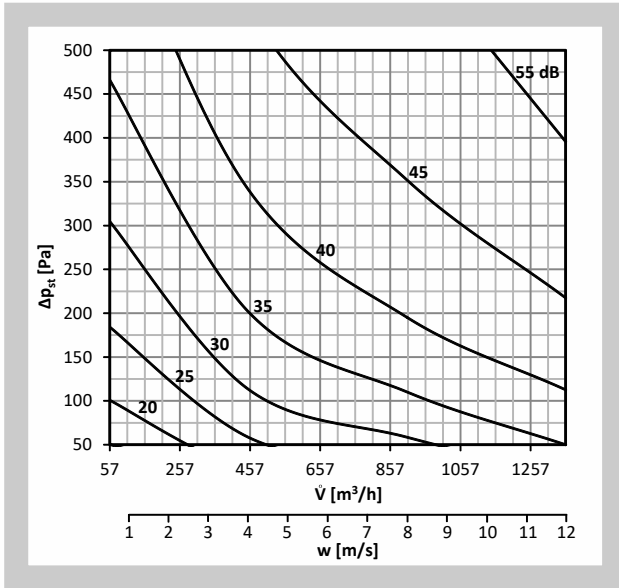

Graph 21 Sound power level LWA [dB(A)] radiated outside the pipeline DN225, without insulation

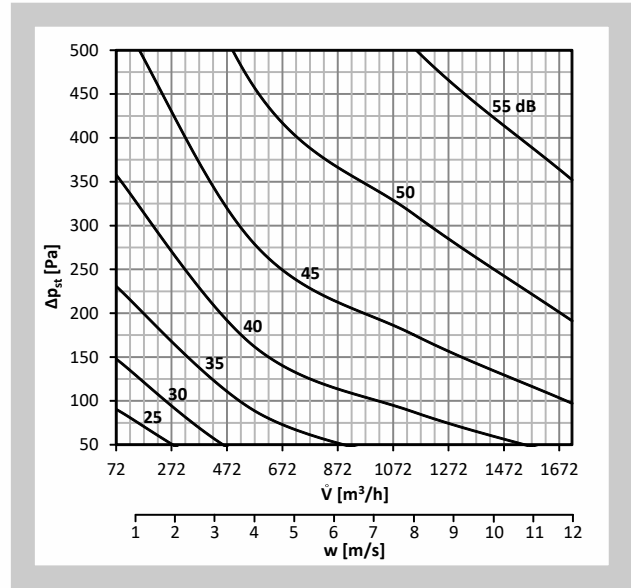

Graph 22 Sound power level LWA [dB(A)] radiated outside the pipeline DN250, without insulation

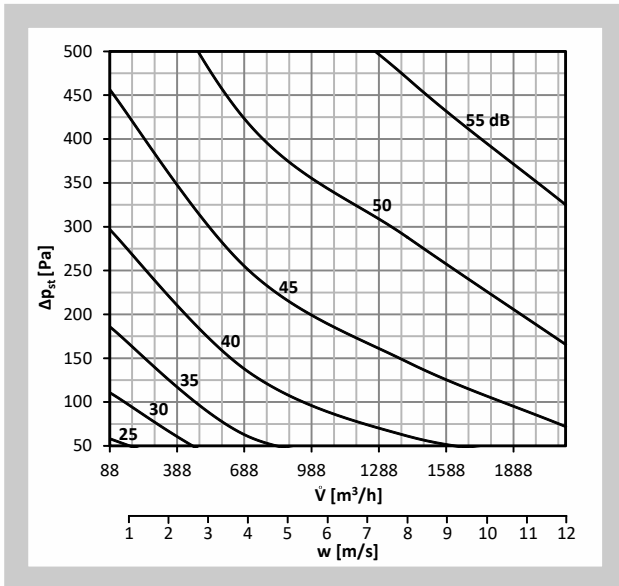

Graph 23 Sound power level LWA [dB(A)] radiated outside the pipeline DN280, without insulation

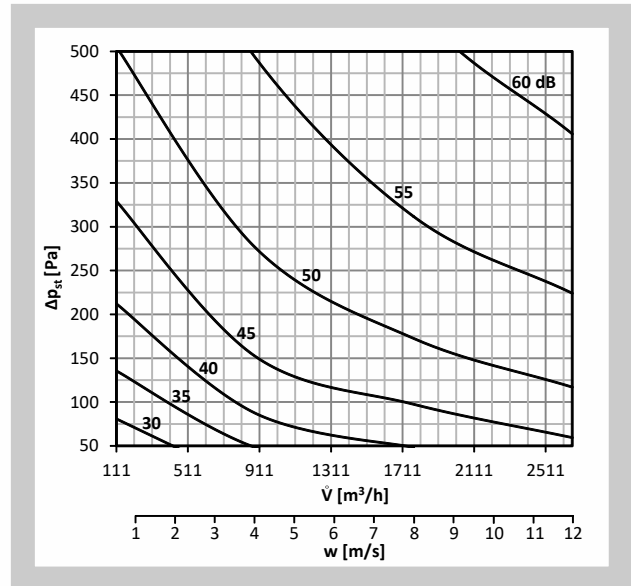

Graph 24 Sound power level LWA [dB(A)] radiated outside the pipeline DN315, without insulation

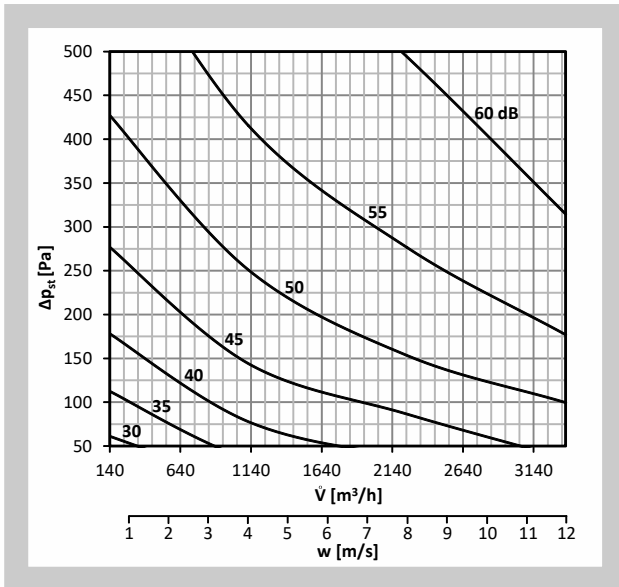

9.3. Radiated noise - with insulation

The radiated noise of air volume controller is listed in Tab. 9.3.1.

\dot{V} [m³/h] - air flow volume

L_{WA} [dB(A)] - total level of acoustic power corrected by filter A

Δp_{st} [Pa] - control pressure drop

Tab. 9.3.1. Sound power level radiated outside the pipeline - with insulation

Nominal Size [mm]	\dot{V} [m ³ /h]	L_{WA} [dB(A)]	L_{WA} [dB(A)]	L_{WA} [dB(A)]	L_{WA} [dB(A)]
		$\Delta p_{st} = 50$ Pa	$\Delta p_{st} = 100$ Pa	$\Delta p_{st} = 250$ Pa	$\Delta p_{st} = 500$ Pa
80	9	<15	<15	17	24
	72	17	20	26	32
	145	23	26	31	36
	217	26	29	34	39
100	14	<15	<15	19	26
	113	18	21	27	32
	226	23	26	31	36
	339	27	30	35	40
125	22	10	13	19	25
	177	18	21	26	31
	353	22	25	30	35
	530	25	28	33	38
140	28	<15	16	22	28
	222	19	22	28	34
	443	24	27	33	39
	665	28	31	37	43
160	36	<15	17	23	29
	290	19	23	30	35
	579	24	28	34	39
	869	28	32	37	42
180	46	<15	<15	18	22
	336	16	19	24	28
	733	21	24	28	32
	1099	25	28	32	35
200	57	<15	<15	19	24
	452	17	20	25	30
	905	22	25	30	34
	1357	27	30	34	38
225	72	12	15	20	25
	573	18	21	26	31
	1145	24	27	32	36
	1718	28	31	36	40
250	88	<15	15	20	25
	707	19	22	27	31
	1414	25	28	33	37
	2121	30	33	37	41
280	111	<15	17	22	27
	887	20	23	28	32
	1773	26	29	34	38
	2660	30	33	38	42
315	140	15	18	23	28
	1122	21	24	29	34
	2244	29	32	37	41
	3367	36	39	44	48

Graph 25 Sound power level LWA [dB(A)] radiated outside the pipeline DN80, with insulation

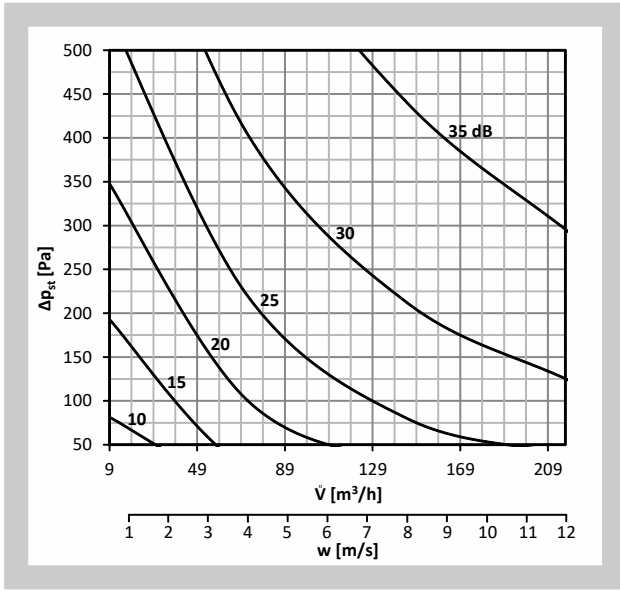

Graph 26 Sound power level LWA [dB(A)] radiated outside the pipeline DN100, with insulation

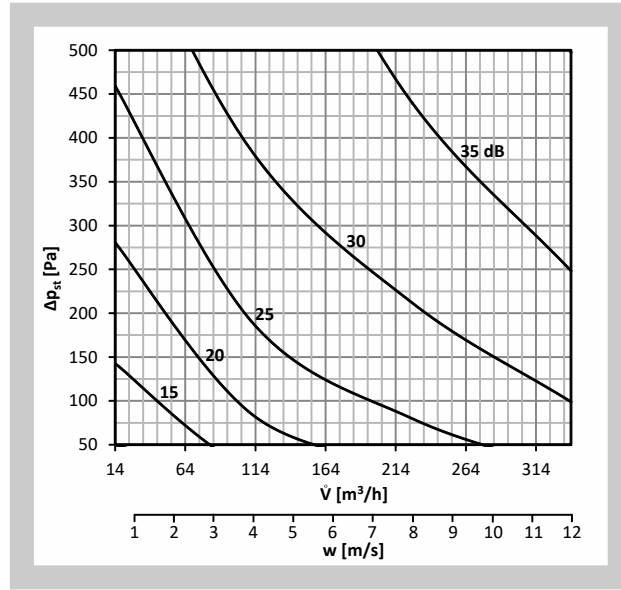

Graph 27 Sound power level LWA [dB(A)] radiated outside the pipeline DN125, with insulation

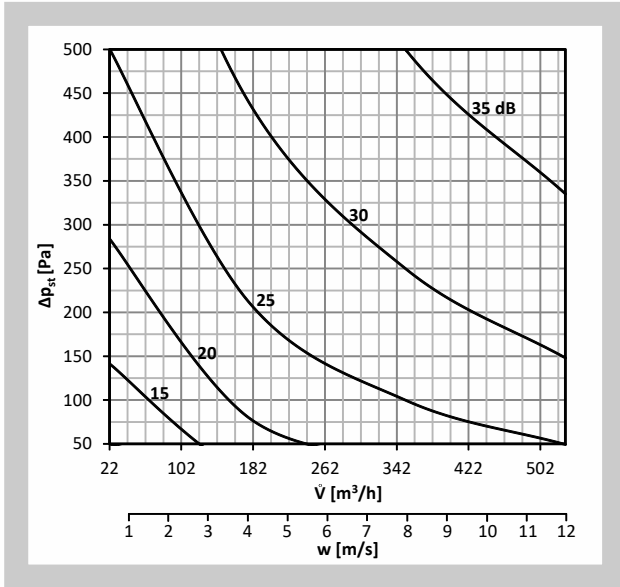

Graph 28 Sound power level LWA [dB(A)] radiated outside the pipeline DN140, with insulation

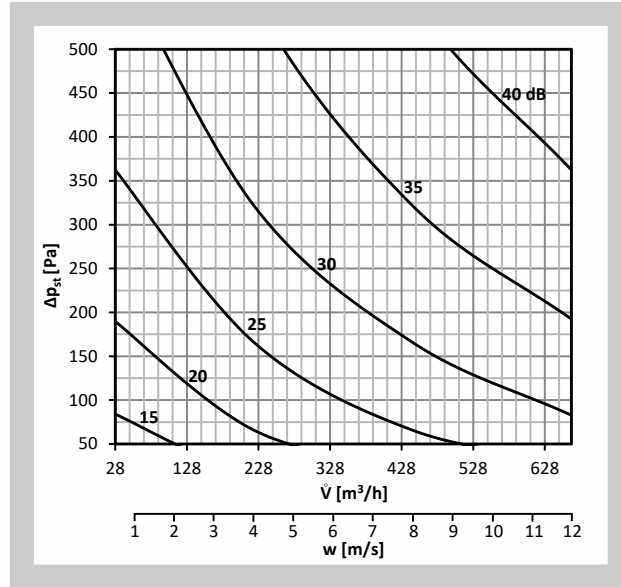

Graph 29 Sound power level LWA [dB(A)] radiated outside the pipeline DN160, with insulation

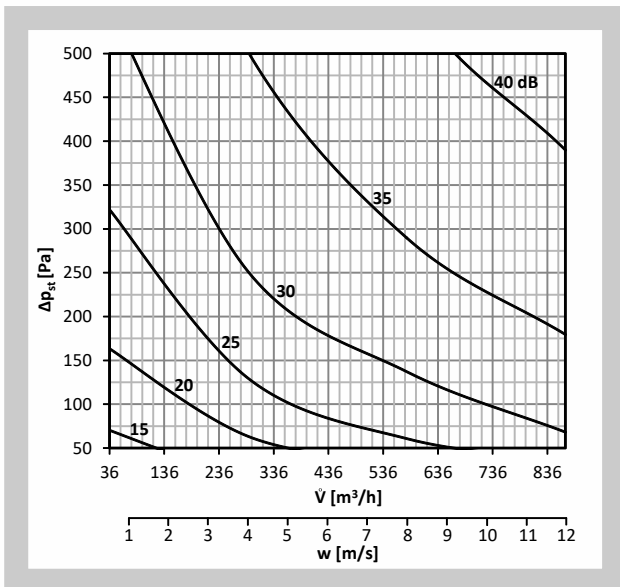

Graph 30 Sound power level LWA [dB(A)] radiated outside the pipeline DN180, with insulation

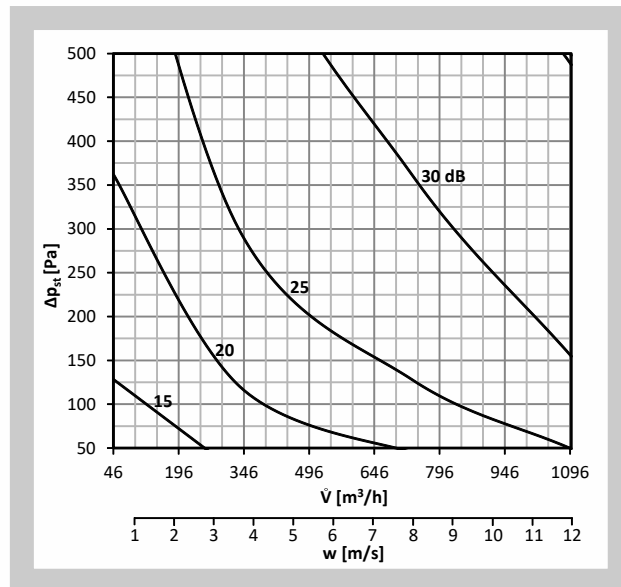

Graph 31 Sound power level LWA [dB(A)] radiated outside the pipeline DN200, with insulation

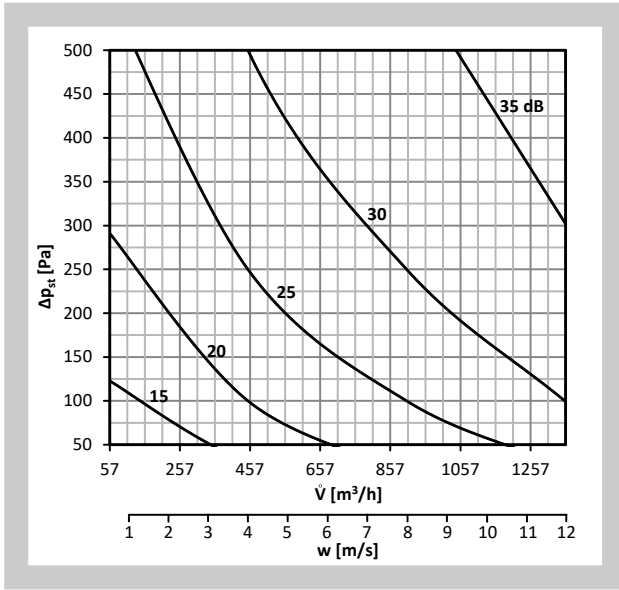

Graph 32 Sound power level LWA [dB(A)] radiated outside the pipeline DN225, with insulation

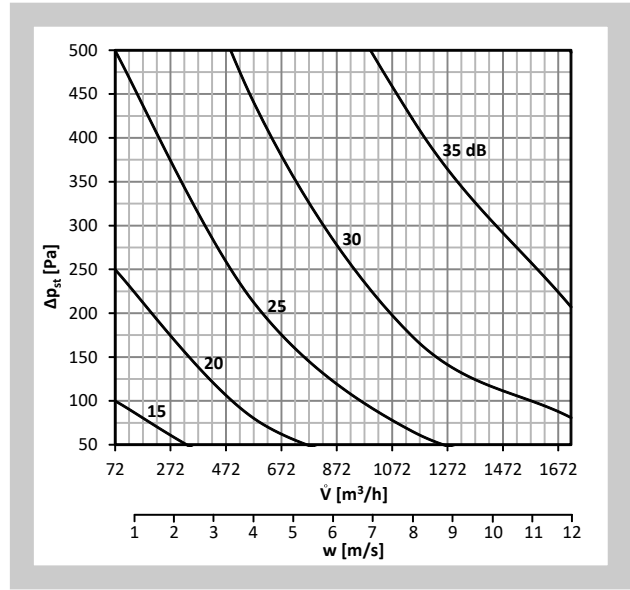

Graph 33 Sound power level LWA [dB(A)] radiated outside the pipeline DN250, with insulation

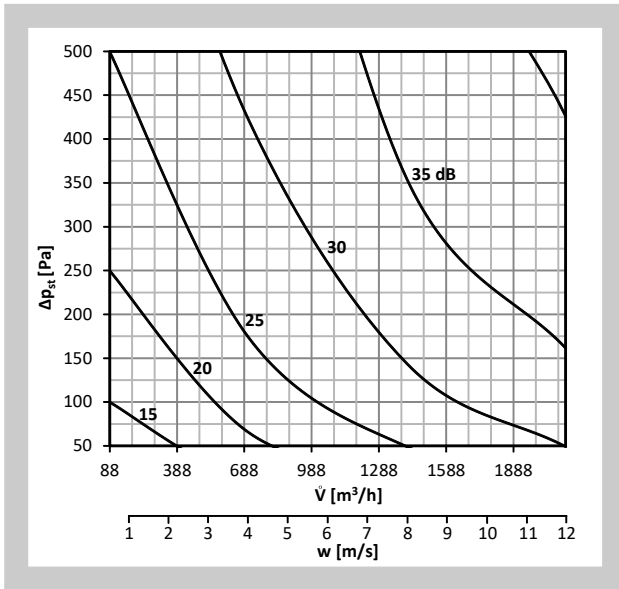

Graph 34 Sound power level LWA [dB(A)] radiated outside the pipeline DN280, with insulation

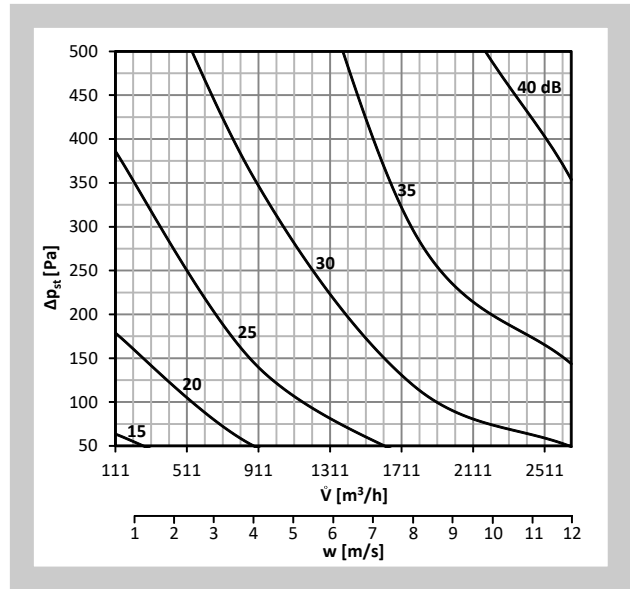

Graph 35 Sound power level LWA [dB(A)] radiated outside the pipeline DN315, with insulation

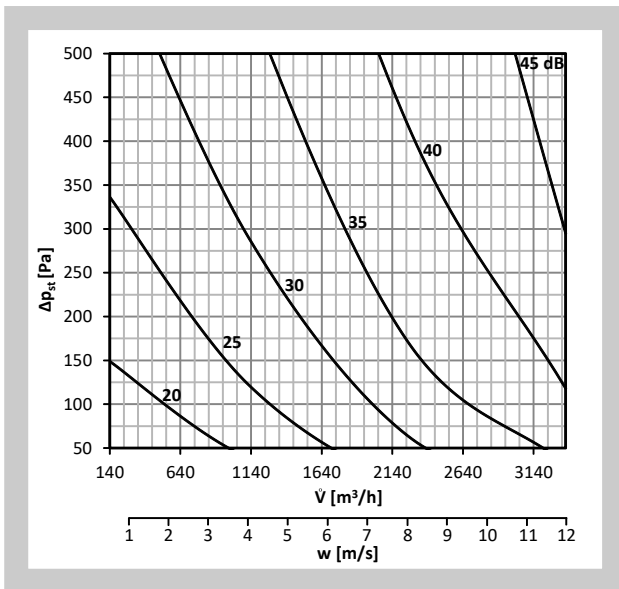

IV. MATERIAL, FINISHING

10. Material

- 10.1.** The controller body and the controller blade are made of galvanized sheet. The blade is furnished with a seal along its periphery. Controllers are with duct seal and glued all the way around. The controller is delivered without further surface treatment.

V. INSPECTION, TESTING

11. Inspection

- 11.1.** Factory quality check is carried out, including final programming and quality control.
- 11.2.** Interoperational checks of components and main dimensions are carried out according to drawing documentation.

12. Testing

- 12.1.** After the assembly, a 100% check of function of closing mechanism and electric components is carried out.

VI. TRANSPORTATION AND STORAGE

13. Logistic terms

- 13.1.** The dampers are delivered as bulk cargo. Any other packing methods must be agreed with the manufacturer in advance. The potential packages will be considered non-returnable and their price will not be included in the product price.

The dampers are transported by box freight vehicles; no sharp shocks must occur and the ambient temperature must not exceed +40°C. For handling during transport, the dampers must be protected against mechanical damages and weather impact. If the customer wishes it, the dampers can be transported on pallets. During transport, the damper blade must be in the "CLOSED" position.

Unless another method of reception is specified in the purchase order, the handover of the dampers to the forwarder shall be understood as reception.

- 13.2.** The dampers must be stored in covered buildings, in an environment without aggressive vapours, gases and dust. A temperature in a range of -5°C and +40°C and a relative humidity of max. 80% must be maintained in the buildings.

For handling during storage, the dampers must be protected against mechanical damage.

For the transportation and storage of compact VAV controllers as spare parts, the following conditions apply: -20 °C to +80 °C with non-condensing humidity.

- 13.3.** The delivery includes the complete controller.

14. Warranty

- 14.1.** The manufacturer provides a warranty of 24 months from the date of dispatch for the dampers. The warranty becomes void if the controller is used for other purposes, equipment or working conditions than allowed by these Technical Specifications and in case of mechanical damage during handling, installation or improper maintenance.

- 14.2.** If the dampers are damaged by transport, a record must be written down with the forwarder at reception for later complaint.

VII. INSTALLATION, OPERATION, MAINTENANCE AND REVISIONS

15. Installation and commissioning

- 15.1.**
- Competent personnel shall be used to install the product.
 - Refer to chapter 4.1 for the design of the duct upstream and downstream the controller and for the operating positions of the controller.
 - The duct shall be suspended, supported or otherwise fixed, and protected from excessive chocks and vibrations.
 - The sleeve of the controller body shall be slipped into the duct or, a duct segment shall be thread onto the sleeve; use of suitable seal lubricant is recommended. Appropriate lifting equipment shall be used where needed, and work safety shall be respected. The duct assembly shall be secured against disassembly by mechanical means.
 - Connection of the 2 hoses of differential pressure intake to the compact VAV controller shall be visually checked as well as any possible damage of the hoses.
 - Check as any possible damage of the connecting cable. The end of the cable should be secured to prevent damages or injuries.
 - Electric installation and commissioning shall be carried out by personnel with adequate permissions.

15.2. Factory pre-set values of \dot{V}_{min} and \dot{V}_{max} may be modified, whereas the Factory disclaims responsibility for such modifications.

Contact BELIMO for more information about communication hardware/software.

Tab. 15.2.1. Modifications of the setup

Actuator BELIMO	Compact VAV controller
Controls on the actuator	–
Wireless command (not available in MOD version)	Mobile devices with NFC interface (Android) Mobile devices with Bluetooth interface using BELIMO Bluetooth–NFC transducer (both Android and iOS)
Separate communication hardware	ZTH-EU including service plug and USB cable
Communication software	PC-Tool
Advice	Do not change \dot{V}_{min} below minimum air flow values indicated in par. 5.1 to guarantee reliable and accurate operation

15.3. Maintenance, interventions

The controller is maintenance free.

In case of an accident in the HVAC system generating pollution (dust particles et.), the pressure intake terminals + and - of the controller may be cleaned from the outside of the duct (without dismounting the duct). Contact the factory for more instructions when needed.

Warning: Do not blow pressurized air to or through the compact VAV controller, directly or indirectly.

VIII. QUICK SELECTION GUIDE

16. Controller size selection

Fig. 16 Controller size selection according to air flow [m³/h]

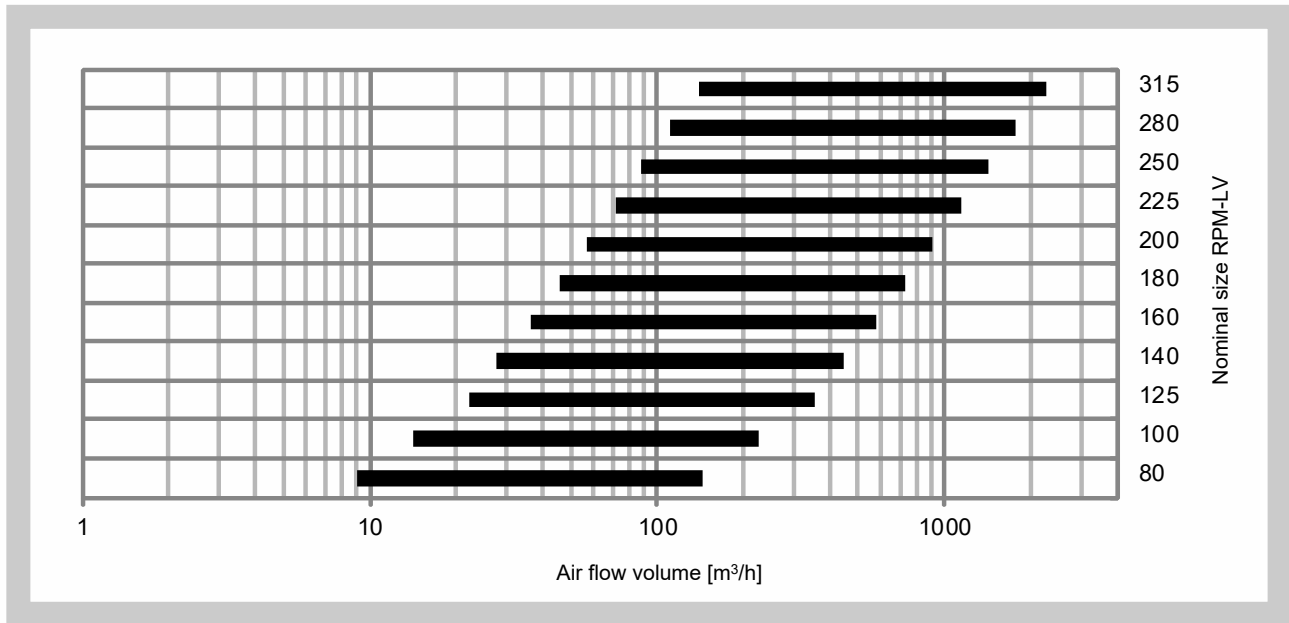
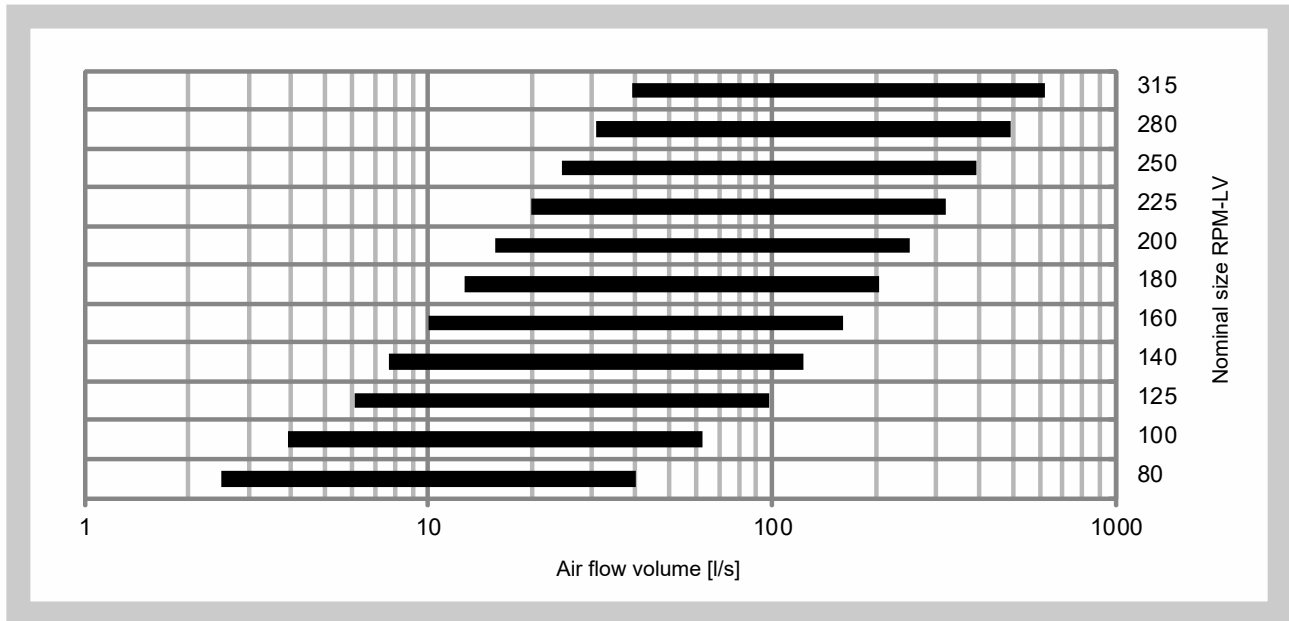

Fig. 17 Controller size selection according to air flow [l/s]



IX. ORDERING INFORMATION

17. Ordering key

17.1. Air flow controller RPM-LV

RPM-LV 160 36 / 579 I K LB01 TPM 144/19

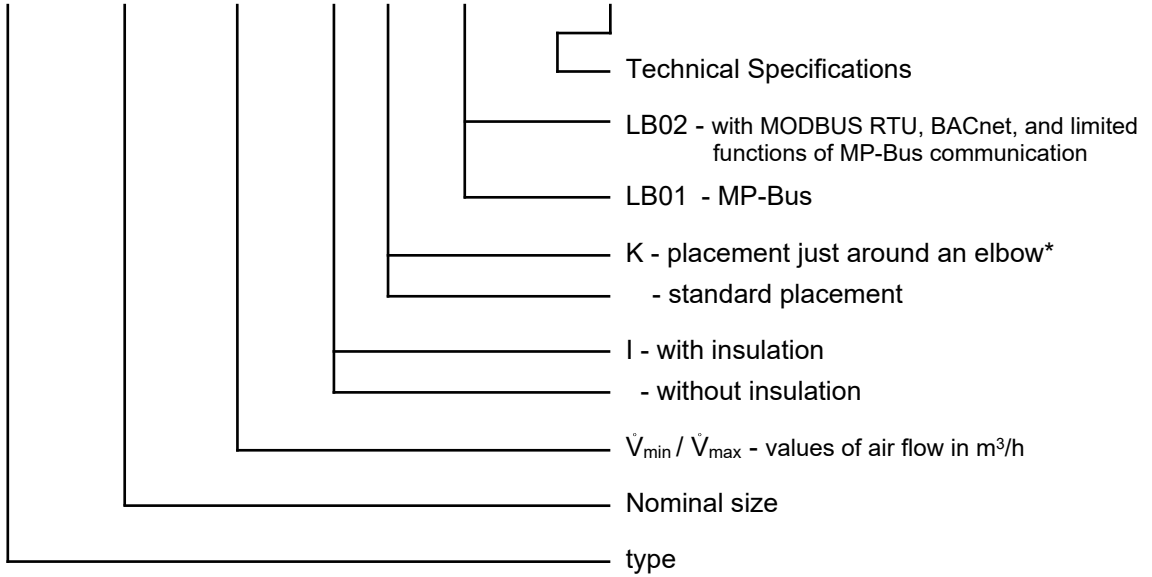

The standard operating mode is set for DC 2 ...10 V input/output. On customer request, it may be set to DC 0 ... 10 V.

In not specified otherwise, controllers are delivered with MP-Bus communication.

Controllers is designed for spiro duct; it is delivered with 2-lips seal.

The values of air volume flow \dot{V}_{min} and \dot{V}_{max} will be set by the manufacturer according to the customer order, otherwise to the full air volume flow range. These values may be later changed by means of ZTH-EU, or by PC-Tool software for PC or via Belimo Assistant App.

* Should the controller be placed just around an elbow while keeping the accuracy of the control, such information shall be shown on the purchase order; the actuator to be programmed with appropriate correction by the Manufacturer.

MANDÍK, a.s.
Dobříšská 550
26724 Hostomice
Czech Republic
Tel.: +420 311 706 706
E-Mail: mandik@mandik.cz
www.mandik.com

The producer reserves the right for innovations of the product. For actual product information see
www.mandik.com