

Safe Change Filter Housing, Type SCF_{hightec}



Aerosol- and Dust Removal Systems

Ventilation systems in areas like laboratories, chemical, pharmaceutical or nuclear industry have to separate toxic particles, radioactive particles and pathogen agents in order to save the environment, the production or the health of the personnel.

Filter systems have to meet high demands regarding the safety and efficiency of particle separation. For these applications Krantz developed the Safe Change Filter Housing, Type SCF_{hightec}. The SCF_{hightec} filter housing is customizable for almost all sophisticated filtering demands.

Various technical high-quality options to equip the system like e.g.

- an integrated scanner device for an online efficiency measurement resp. leak testing
 - an automatic disinfection device, to be connected gastightly to the filter housing, utilise a disinfection of the filter housing and filter media
 - a gastight shut-off slide or shut-off damper, which is integrated in the air inlet- and outlet chamber
- complete the offer of this product.

Characteristics

- Compact construction
- Modular design according to a modular kit principle
- Many different outfitting possibilities

The construction based on long time experience regarding

- applications
- used materials
- tightness requirements
- online efficiency measurements
- decontamination and disinfection
- contamination free exchange of filter elements
- testing and inspection

The construction is characterised of compact design and many different outfitting.

Because of

- a modular design
- only one side needed for operation
- the free choice of the arrangement vertical resp. horizontal
- different air inlet- and outlet chambers the filter housing is predestined for special requirements and locations with less space.

Filter (basic module)

Standardised construction elements for the complete filter line:

- Test groove to check the seat of the filter elements
- Clamping device
- Semi-automatic filter exchange mechanism
- Maintenance cover for the filter insertion ports
- Standard filter elements
- Special collar to utilise the safe change process

Filter arrangements

- Different filter stages one after the other e.g. fine dust- and HEPA filter stage
- Standard filter elements (dimensions 610×610mm) arranged in each filter stage side by side in lines and one above the other in columns

Semi-automatic filter exchange mechanism

By pulling the sliding strip the filter will slide out smoothly to the position of the changing collar.

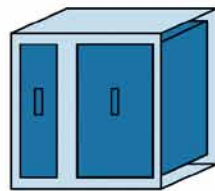
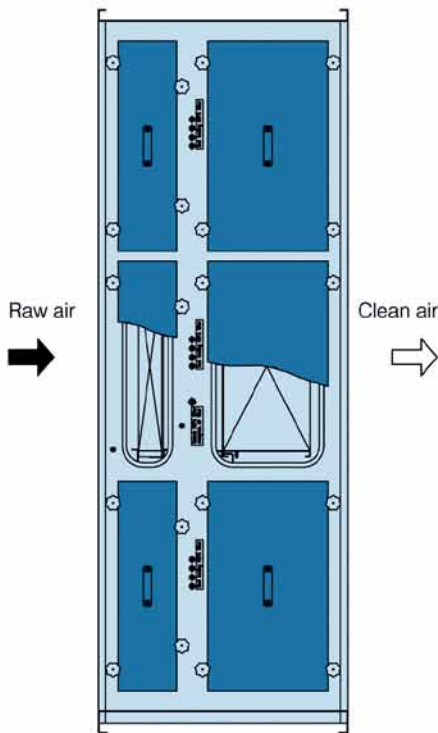

Minimum size of housing
Arrangement 1×1

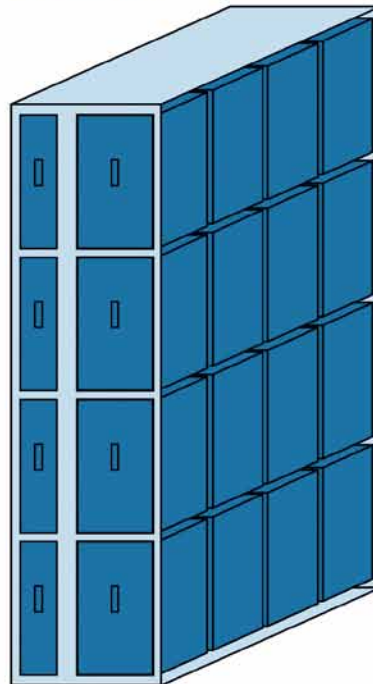

Maximum size of housing
Arrangement 4×4

Requirement for contamination free exchange of filter elements during operation:
filter system $n + 1$

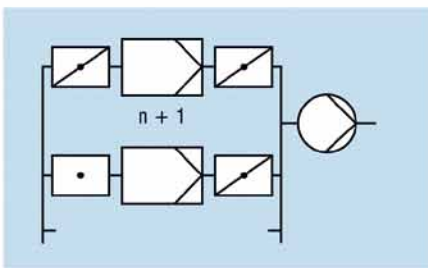

Integrated scanner system

for online efficiency measurement, for detecting of leak in filter media.

To determine the filter efficiency a certain sample air flow will be taken on the raw gas side as well as on the clean gas side to receive

the distribution and concentration of particles in each single particle class. By means of an optical particle counter the integral filter efficiency for each filter class corresponds to the quotient of the particle concentration on raw gas side and clean gas side. The particle

class with the worst efficiency (Most Penetrating Particle Size) has to fulfil the requirements according to EN 1822, e.g. filter class H13 99,95 %.

Type of housing:

SCF_{hightec} 2x3 [2 columns, 3 lines]

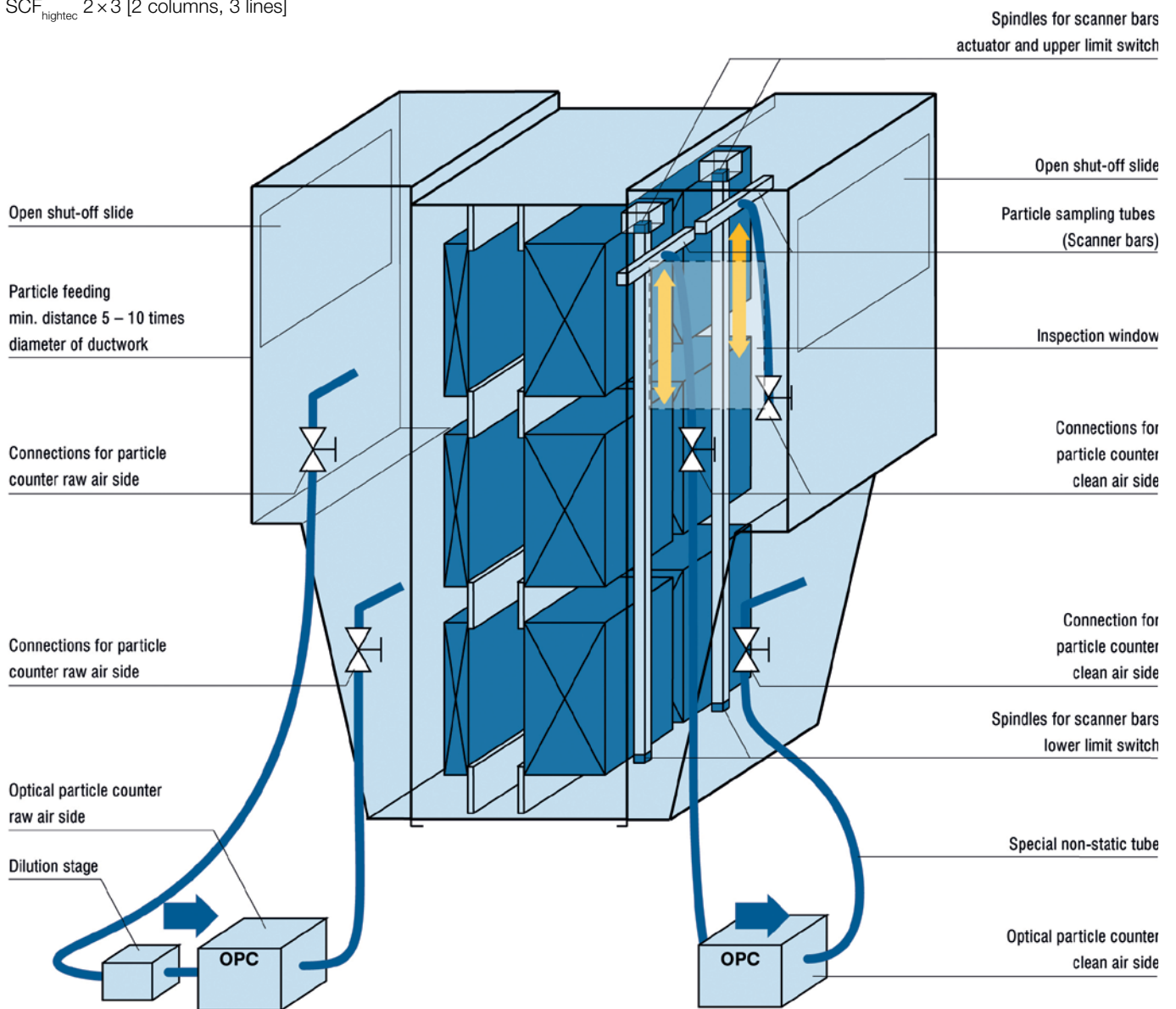

Disinfection device

for a disinfection and afterwards neutralisation of the filter housing and the filter media.

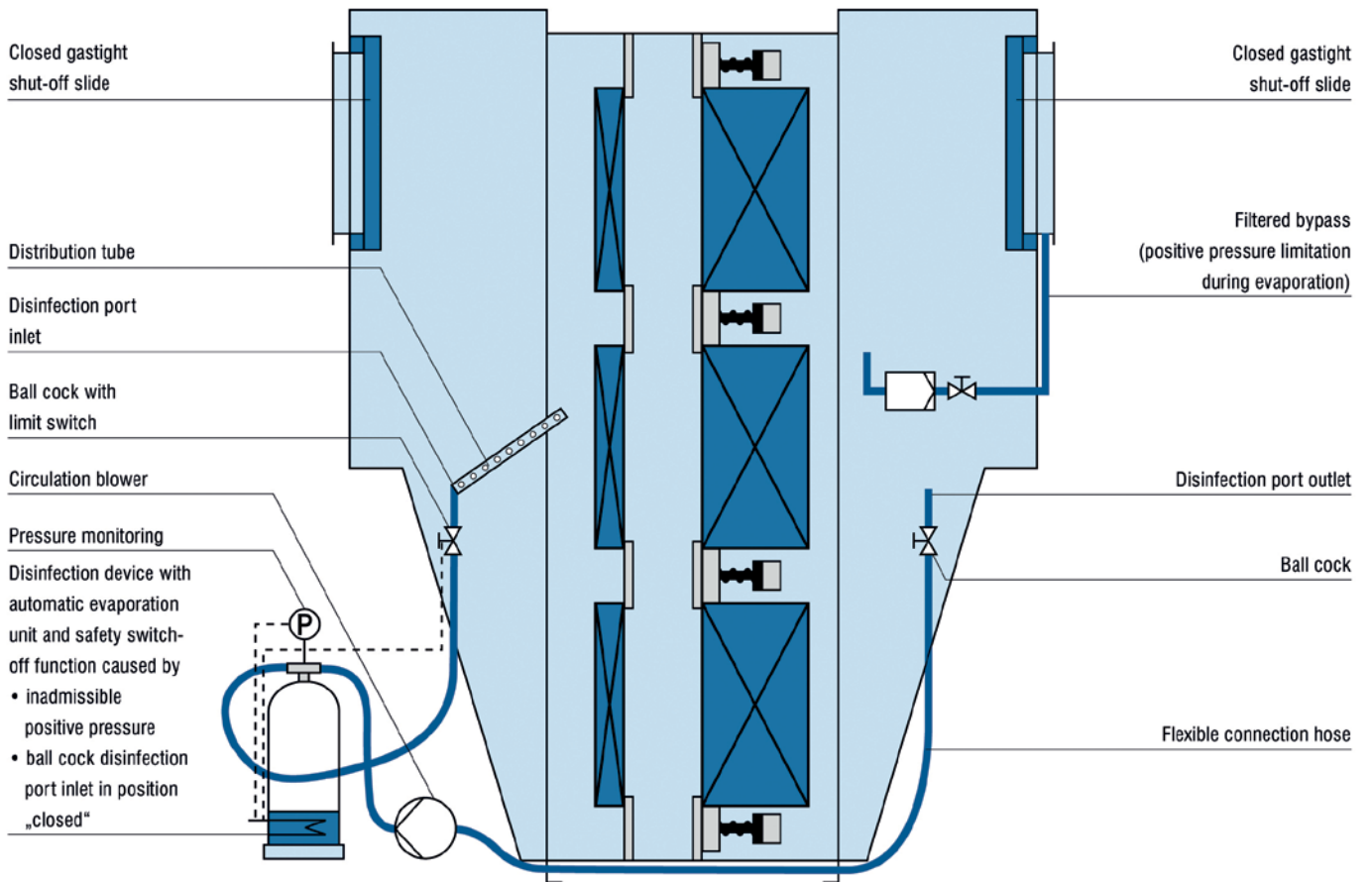

Fully Equipped

Safe Change Filter Housing, Type SCF_{hightec}

- Pressure gauge for fine dust- and HEPA filter stage
- Tightness proof frames to check tightness of HEPA filter sealings and the damper blade seats
- Self-adjusting clamping mechanism Fully Equipped
- Disinfection ports
- Integrated gastight shut-off slide
- Ports for raw- and clean air particle measurement
- Integrated moving scanner system for on-line efficiency measurement and leak test

Basic filter module

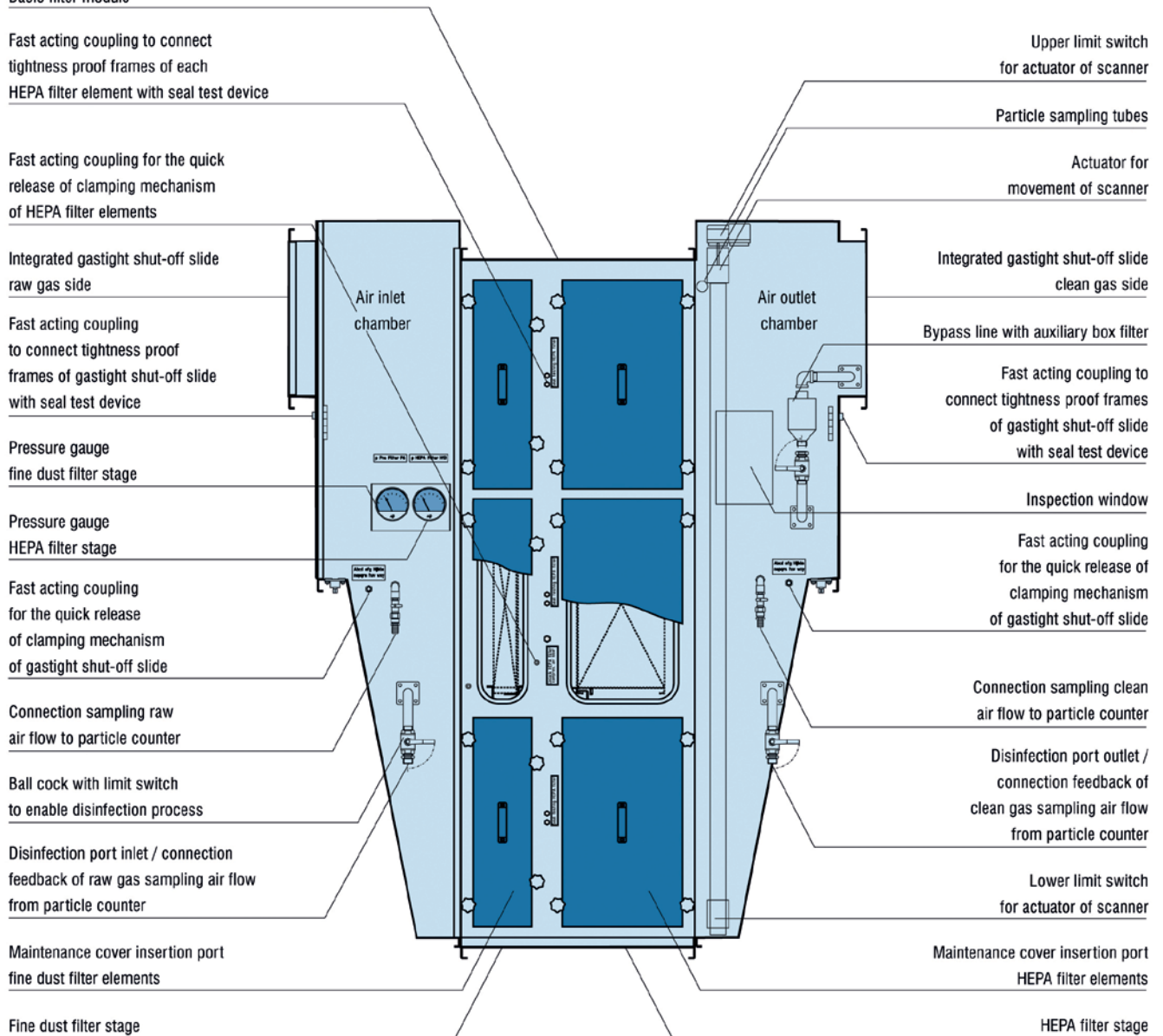

Dimensions and weights

Filter module SCF_{hightec}

n x m, n = number of columns,
m = number of lines

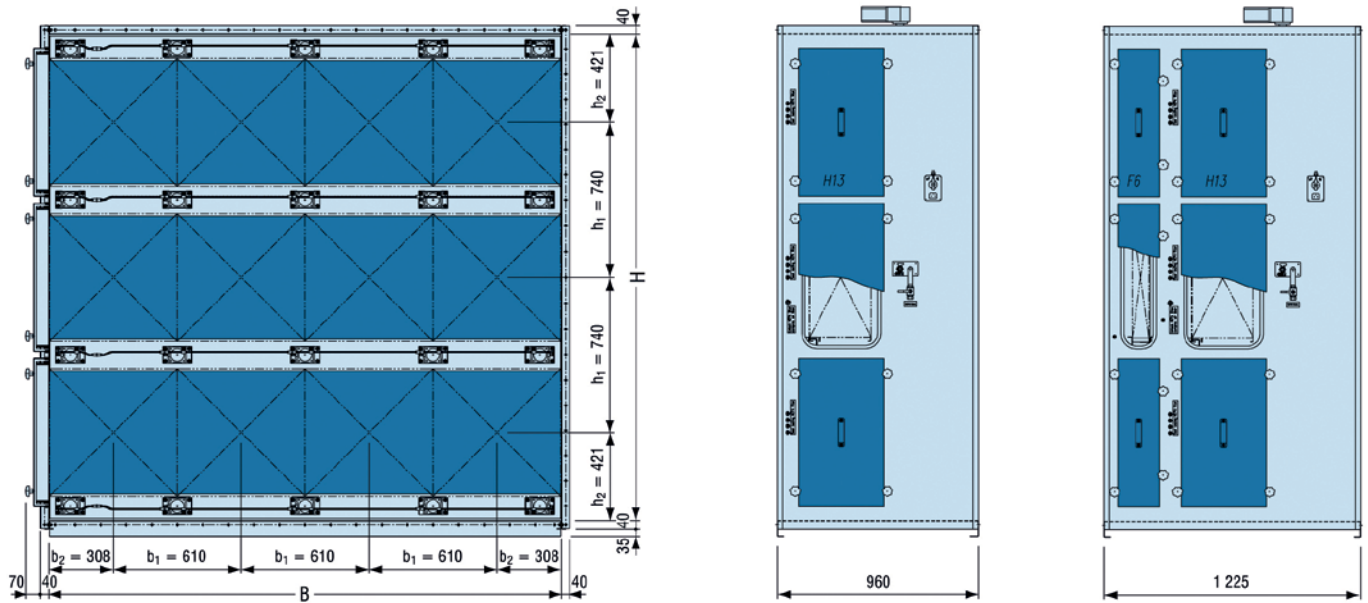

m lines		n columns			
		1	2	3	4
1	\dot{V}_{nom} [m ³ /h]	3 000	6 000	9 000	12 000
	m* [kg]	130	195	265	330
	H [mm]	2 x h ₂ = 840	2 x h ₂ = 840	2 x h ₂ = 840	2 x h ₂ = 840
	B [mm]	2 x b ₂ = 614	1 x b ₁ + 2 x b ₂ = 1 224	2 x b ₁ + 2 x b ₂ = 1 834	3 x b ₁ + 2 x b ₂ = 2 444
2	\dot{V}_{nom} [m ³ /h]	6 000	12 000	18 000	24 000
	m* [kg]	205	300	395	490
	H [mm]	1 x h ₁ + 2 x h ₂ = 1 580	1 x h ₁ + 2 x h ₂ = 1 580	1 x h ₁ + 2 x h ₂ = 1 580	1 x h ₁ + 2 x h ₂ = 1 580
	B [mm]	2 x b ₂ = 614	1 x b ₁ + 2 x b ₂ = 1 224	2 x b ₁ + 2 x b ₂ = 1 834	3 x b ₁ + 2 x b ₂ = 2 444
3	\dot{V}_{nom} [m ³ /h]	9 000	18 000	27 000	36 000
	m* [kg]	275	405	525	645
	H [mm]	2 x h ₁ + 2 x h ₂ = 2 320	2 x h ₁ + 2 x h ₂ = 2 320	2 x h ₁ + 2 x h ₂ = 2 320	2 x h ₁ + 2 x h ₂ = 2 320
	B [mm]	2 x b ₂ = 614	1 x b ₁ + 2 x b ₂ = 1 224	2 x b ₁ + 2 x b ₂ = 1 834	3 x b ₁ + 2 x b ₂ = 2 444
4	\dot{V}_{nom} [m ³ /h]	12 000	24 000	36 000	48 000
	m* [kg]	360	510	655	805
	H [mm]	3 x h ₁ + 2 x h ₂ = 3 060	3 x h ₁ + 2 x h ₂ = 3 060	3 x h ₁ + 2 x h ₂ = 3 060	3 x h ₁ + 2 x h ₂ = 3 060
	B [mm]	2 x b ₂ = 614	1 x b ₁ + 2 x b ₂ = 1 224	2 x b ₁ + 2 x b ₂ = 1 834	3 x b ₁ + 2 x b ₂ = 2 444

* Masses are meant without filter elements

Text for tender

Safe Change Filter Housing

For the separation of airborne particles and aerosols, provide for a vertical arrangement of the following particulate air filter elements:

- Fine dust filter element;
W/H/D 610/610/78 [mm];
filter class F. acc. to EN 779
- HEPA filter element;
W/H/D 610/610/292 [mm];
filter class H.. acc. to EN 1822

General

- Extreme compact construction, by means of an arrangement of the filter elements side by side (lines) and one above the other (columns).
- All media touched parts are welded continuously and without gaps to ensure an easy decontamination.
- The clamping device of the HEPA filter elements is operated from outside and proportioned to ensure the tightness requirements for the seat of the filter element according to DIN 25 496, table 3, under conditions of maximum loading of the filter elements and a retreating sealing.
- The filter housing design allows the exchange of the filter elements by means of the safe change technology and without contamination of operational stuff and environment.
- Profile sealing made of silicon rubber ensures the tightness of the screwed parts of the filter housing. The sealing system is not sticking, therefore the sealing is easy detachable during maintenance work and also reusable.

Design

- Robust filter housing made of stainless steel in gastight design according to the tightness requirements of the DIN 25 496, table 3, to insert fine dust- and HEPA filter elements.
- Intake device for the positioning of fine dust and HEPA filter elements to filter walls with a horizontal air flow [filter wall: arrangement of the filter elements side by side (lines) and one above the other (columns)].
- Front positioned connecting flanges for air inlet- and outlet chamber.
- Separate insertion port for each filter line, equipped with a special collar for the safe change technology.
- Special collar, made of aluminium, with two grooves according to DIN 25 466, supplement 1, to take the hollow rubber band for the plastic bag fixation. Undercut grooves with perfectly matched hollow rubber bands ensure a gastight seat of the plastic bag.
- Maintenance covers made of stainless steel to ensure a gastight closing of the insertion ports and a protection of the special collar and the rolled plastic bag. The covers are fixed to the filter housing, by means of four screwing elements with a star shaped handle. Each cover is equipped with a central positioned transport handle.
- Clamping of the HEPA filter elements by means of self-adjusting spring system, to ensure the tightness requirements for the seat of the filter element according to DIN 25 496, table 3, under conditions of a retreating sealing caused by e.g. aging. Quick release of the clamping device by means of single acting pneumatic cylinders. For filter element exchange supply

of cylinders with compressed air (6 bar oil free and water less) via fast acting coupling positioned at the front side of the filter housing.

- Test groove according to DIN 1946-4 resp. DIN 25 414 for each filter element made of stainless steel. In order to proof the leak free seat of the filter element connect the test groove to the seal test device via fast acting coupling, positioned at the front side on the filter housing.
- Selective reading of the differential pressure of fine dust- and HEPA filter stage to observe the grade of loading by means of a pressure gauge, fabricate Magnehelic[®], instrument holder, connections, and connection tubes.
- Air inlet chamber, made of stainless steel in gastight design. Chamber with connection flanges to filter housing and raw gas duct, devices for an optimal air distribution (if necessary) and inspection port with cover.
- Air outlet chamber, made of stainless steel in gastight design. Chamber with connection flanges to filter housing and clean gas duct and inspection port with cover.

Technical data

Fabricate:	Krantz
Type:	SCF _{hightec} n x m F./H..
Nominal air flow per filter element:	3 000 m ³ /h
Admissible design pressure:	± 6 000 Pa
Design temperature:	90 °C
Tightnes of filter housing acc. to DIN 25 496:	leakage rate < 3 · 10 ⁻⁵ of nominal air flow at Δp = 2 000 Pa
Tightness of filter seat acc. to DIN 25 496:	leakage rate < 3 · 10 ⁻⁵ of nominal air flow at Δp = 2 000 Pa
Radiation resistance:	≤ 10 ⁵ Gy

Fine dust filter elements

Filter class:	F. acc. to EN 779
Dimensions W × H × D:	610 × 610 × 78 mm
Intake capacity and arrangement:	e.g. 12 pieces (4 columns, 3 lines)

HEPA-Filterelemente

Filter class:	H.. gem. EN 1822
Dimensions W × H × D:	610 × 610 × 292 mm
Intake capacity and arrangement:	e.g. 12 pieces (4 columns, 3 lines)

Accessories

Air inlet- and air outlet chamber

Any kind of connections between ductwork and filter housing is available. The vertical arrangement needs less space compared with the common horizontal arrangement, this ad-

vantage will be much bigger if the filter housing will be integrated to a horizontal ductwork, mounted close to the ceiling.

Test rack

Mobile test rack for scanning device and analysis of test result

Integrated gastight shut-off slides



Top connection to ductwork, vertical filter elements



SCF_{hightec} 3x4 with gastight shut-off slides



Central connection to ductwork, vertical filter elements



Gastight shut-off slide



Disinfection device

for a disinfection and afterwards neutralisation of the filter housing and the filter media.



Air inlet- and air outlet chamber

Standard construction

Top connection of ductwork on the same level as upper edge filter housing Example: SCF_{hightec} 3×3

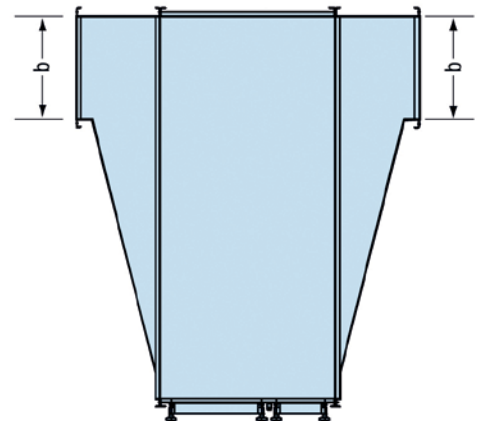
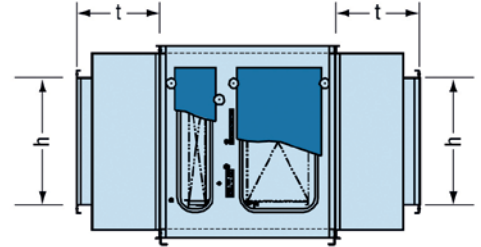
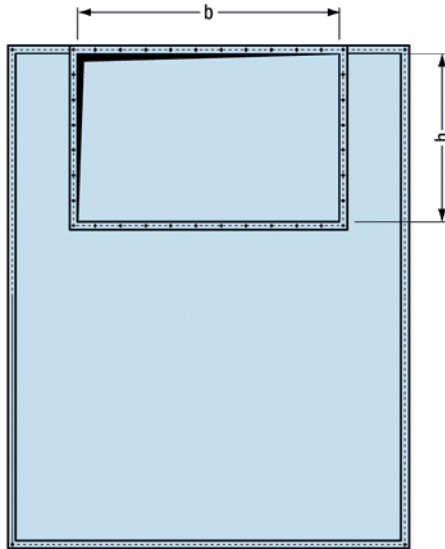
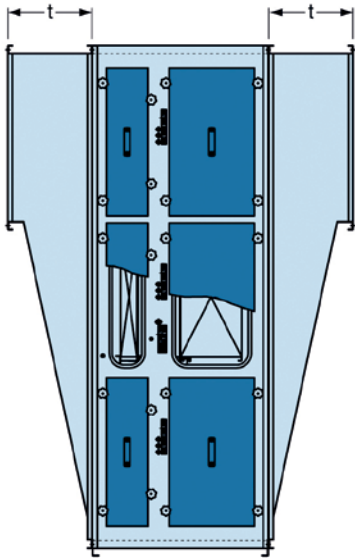

For filter housing with one line we recommend an alternative duct connection. Example: SCF_{hightec} 3×1

The connection between filter module and ductwork can be optimised, by means of individual designed air inlet- and air outlet chambers for special requirements.

Please contact us, if you need assistance for your design.

The listed dimensions and masses are related to the above mentioned standard construction.

m lines		n columns			
		1	2	3	4
1	m _{chamber} [kg]	40	66	92	128
	h [mm]	610	610	610	610
	b [mm]	200	350	500	700
	t [mm]	300	350	400	500
2	m _{chamber} [kg]	61	97	131	163
	h [mm]	350	350	500	500
	b [mm]	618	1 228	1 250	1 600
	t [mm]	300	300	300	300
3	m _{chamber} [kg]	95	145	180	242
	h [mm]	500	500	800	800
	b [mm]	618	1 228	1 250	1 600
	t [mm]	400	400	400	400
4	m _{chamber} [kg]	40	66	92	128
	h [mm]	700	700	1 000	1 000
	b [mm]	618	1 228	1 250	1 600
	t [mm]	500	500	500	500

Air inlet- and air outlet chambers

Examples of alternatives for the construction

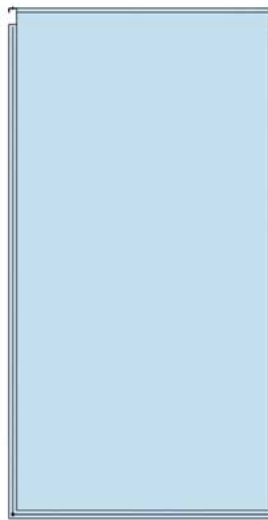
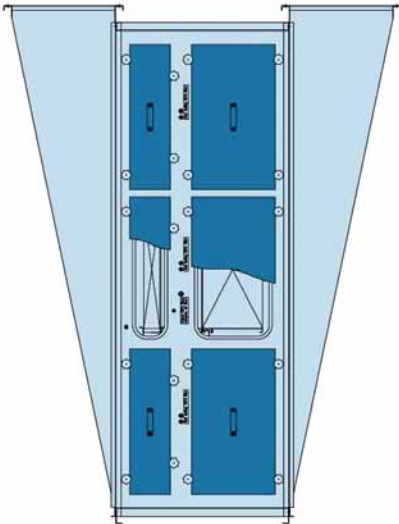

Top connection to ductwork, vertical filter elements

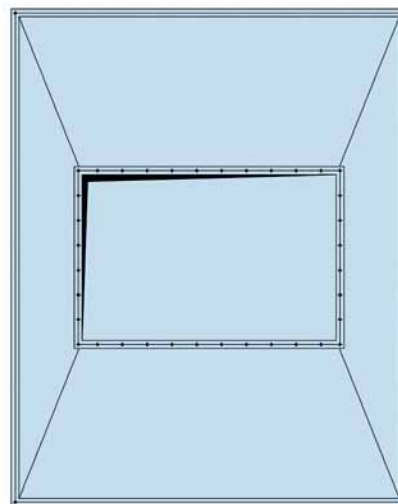
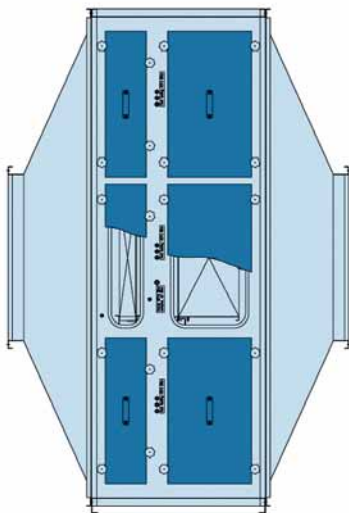

Central connection to ductwork, vertical filter elements

Krantz GmbH

Uersfeld 24, 52072 Aachen, Germany

Phone: +49 241 434-1

Fax: +49 241 434-500

info.filter@krantz.de | www.krantz.de

The logo for Krantz GmbH, featuring the word "Krantz" in a stylized, blue, cursive script font.